

Assembly Instructions

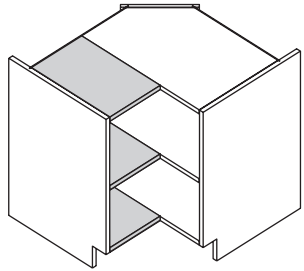

Corner Base Extension

CBE39
CBE36

***SUPPLEMENT TO CORNER
BASE INSTRUCTIONS**

1



BACKBOARD

1

**CBE39
ONLY**



BACKBOARD

2

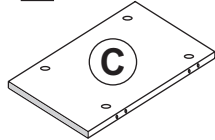

ASSEMBLY SHELF
SMALL

1

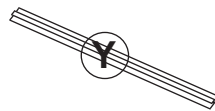

0560 0031

1

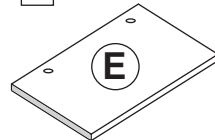

ADJUSTABLE SHELF
SMALL

12

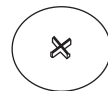

0550 0060



PARTS C AND E ARE REPLACEMENTS FOR SAME PARTS
IN CORNER BASE CABINET. USE THESE PARTS WHEN
INDICATED IN CORNER BASE INSTRUCTION.

2

x 14

x 20

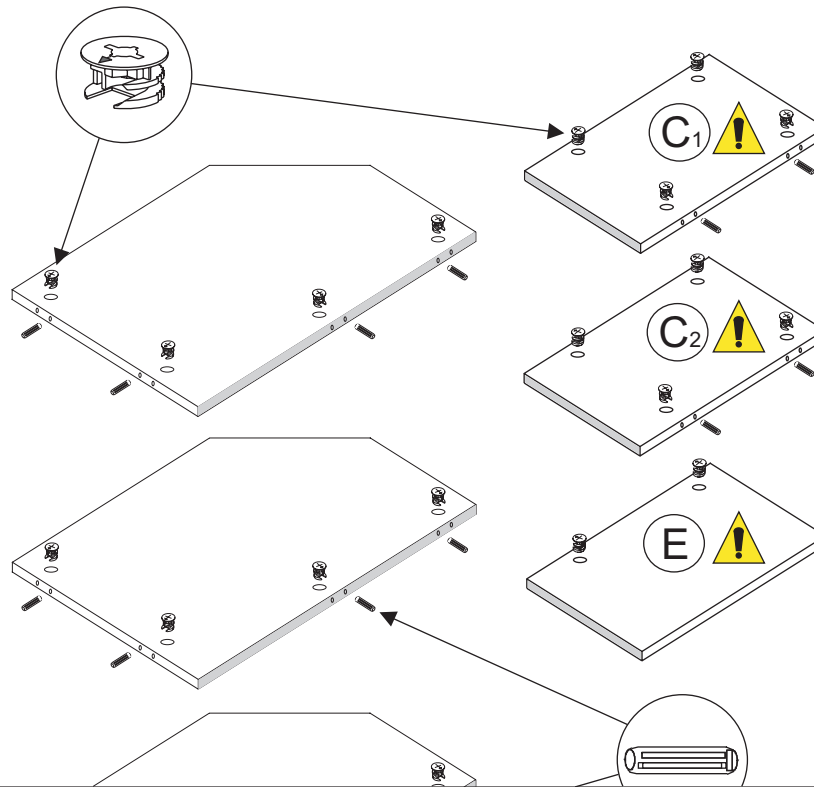

4

x 6

F → D,E

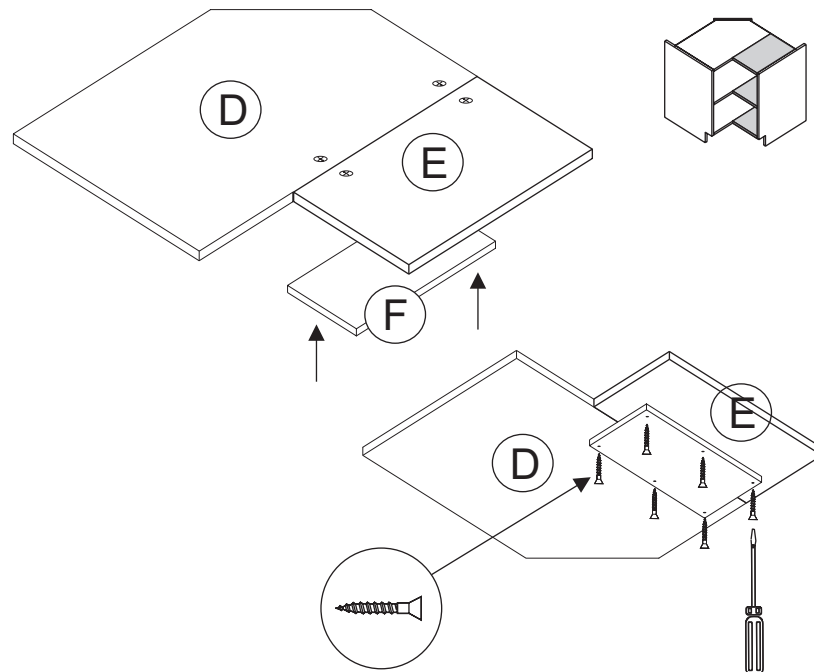

5

B1 → A1
B2 → A1

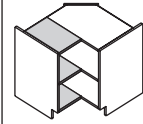

C1 → A1
C2 → A1

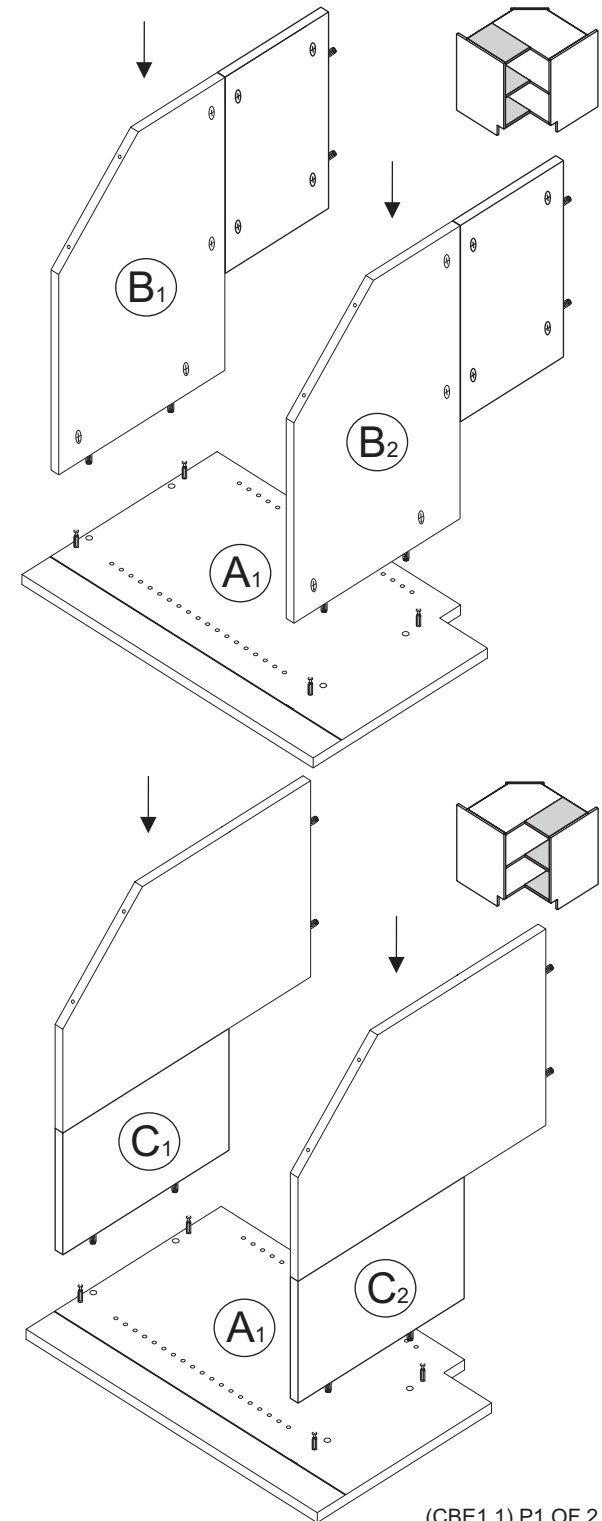
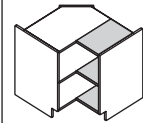

8

x 16

H1 → A1+G
H2 → A2+G

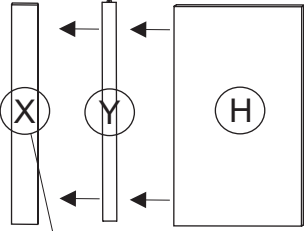

CB33 + CBE39 → X2
 CB33 + CBE36 → X1
 CB36 + CBE39 → X1

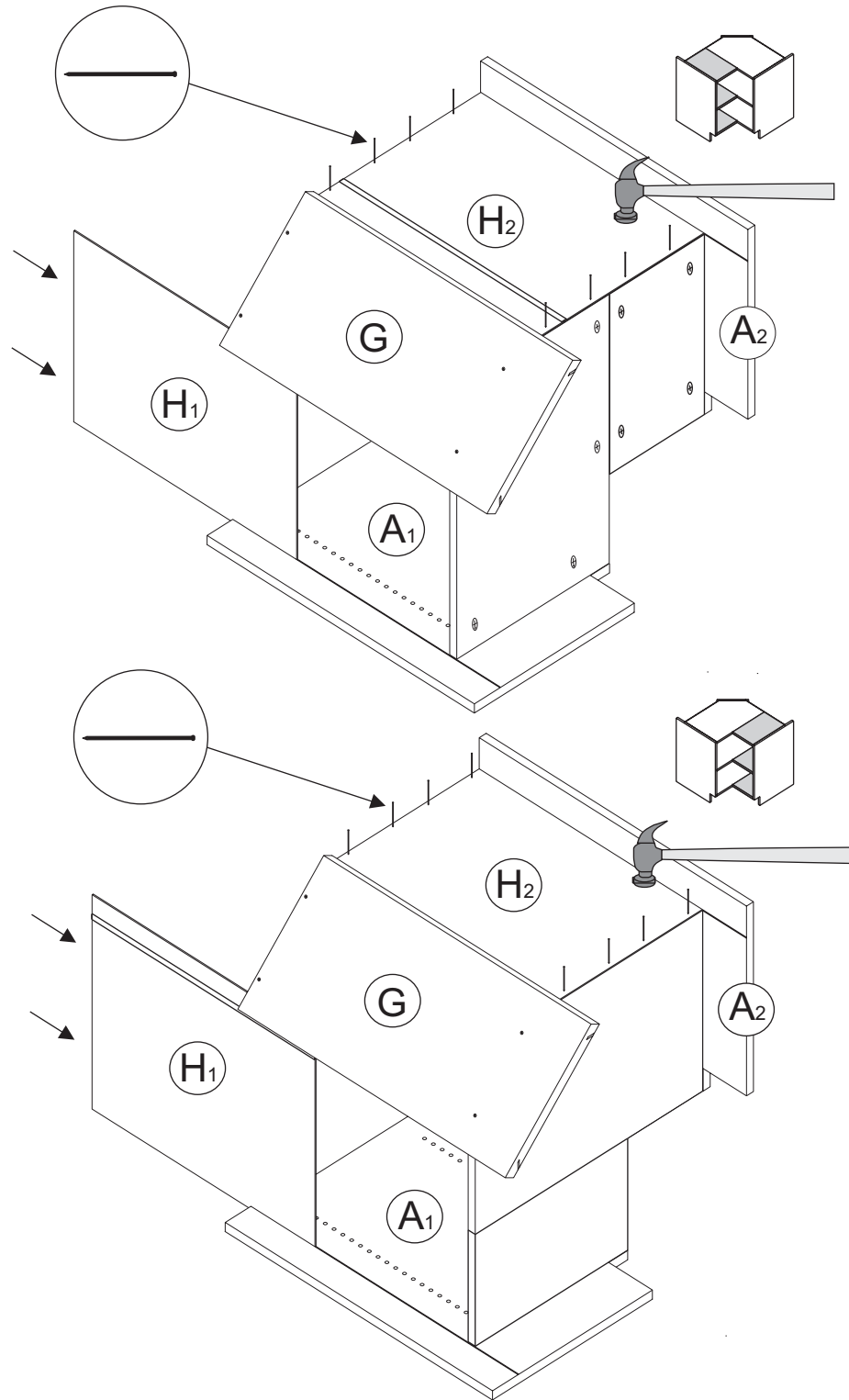
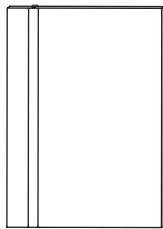
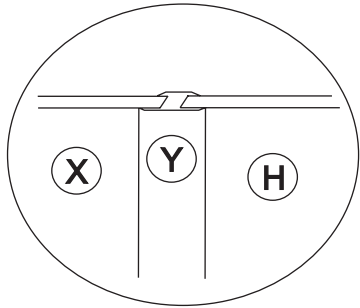

11

x 5

x 12

