

Assembly Instructions

BlindWallCornerPanelKit

BlindBase Corner Panel Kit

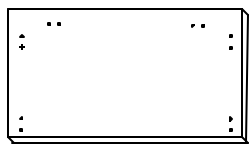
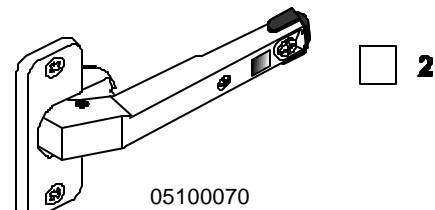
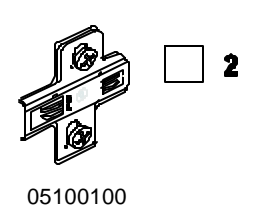
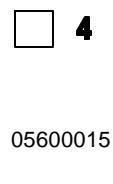
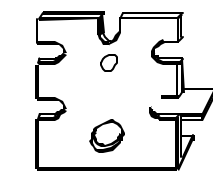
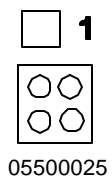
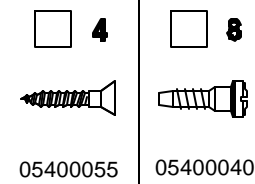
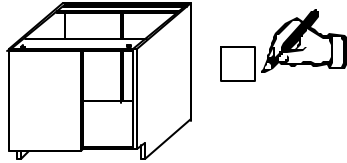
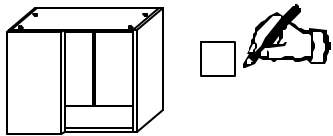

1-A

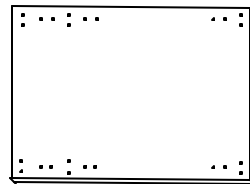

BlindWallPanel

OR

BlindBase Panel

1-B

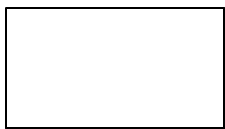

BACKBOARD

1-C



VINYLDIVIDER

1

C → B

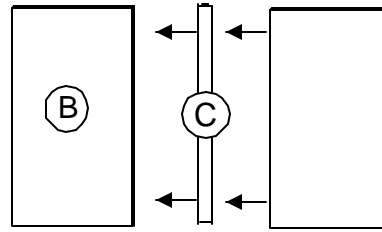

BACKBOARD
FROM
DOORPACK

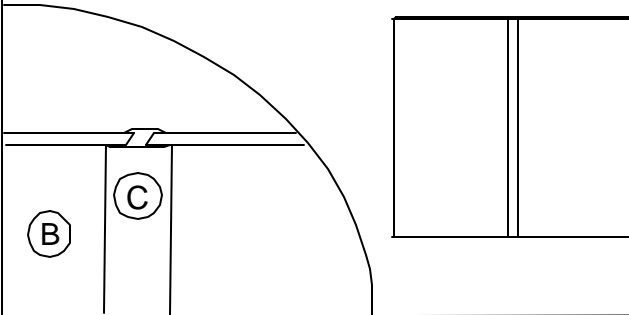

2

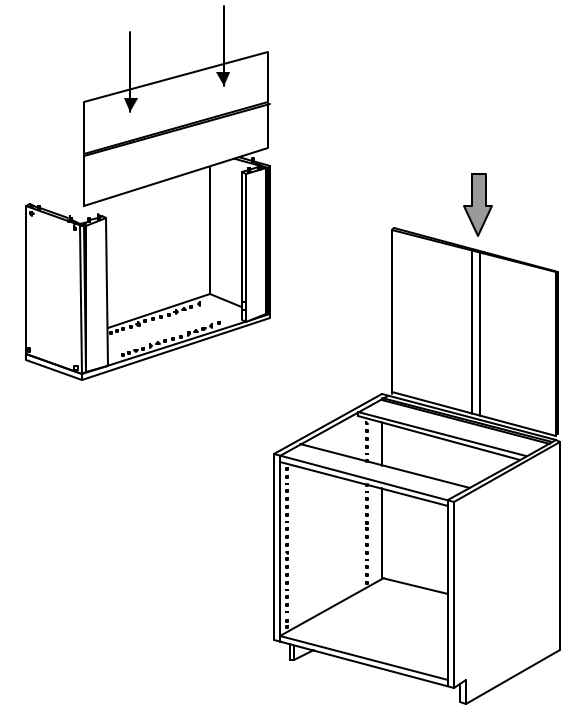

3

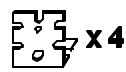

BlindWallPanel

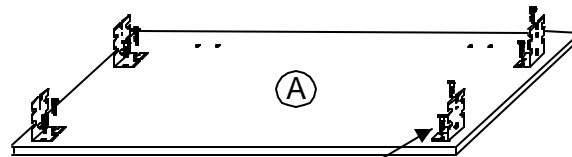

A

BlindBase Panel

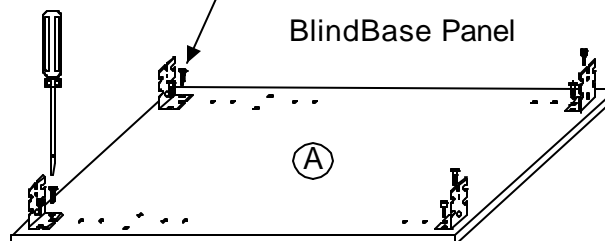

A

4

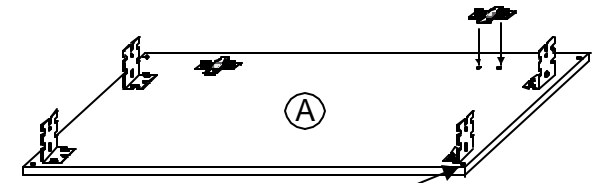
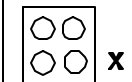
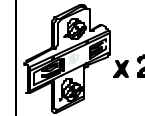

A

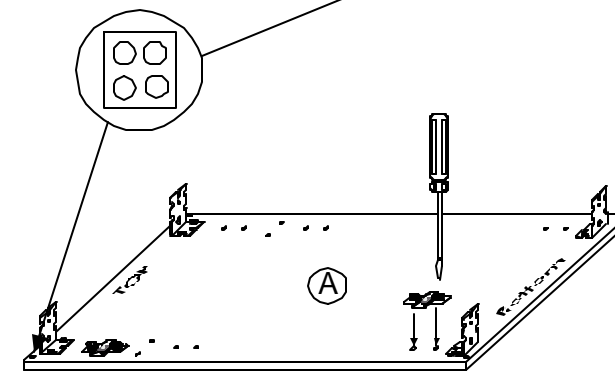

A

5

A → Cab

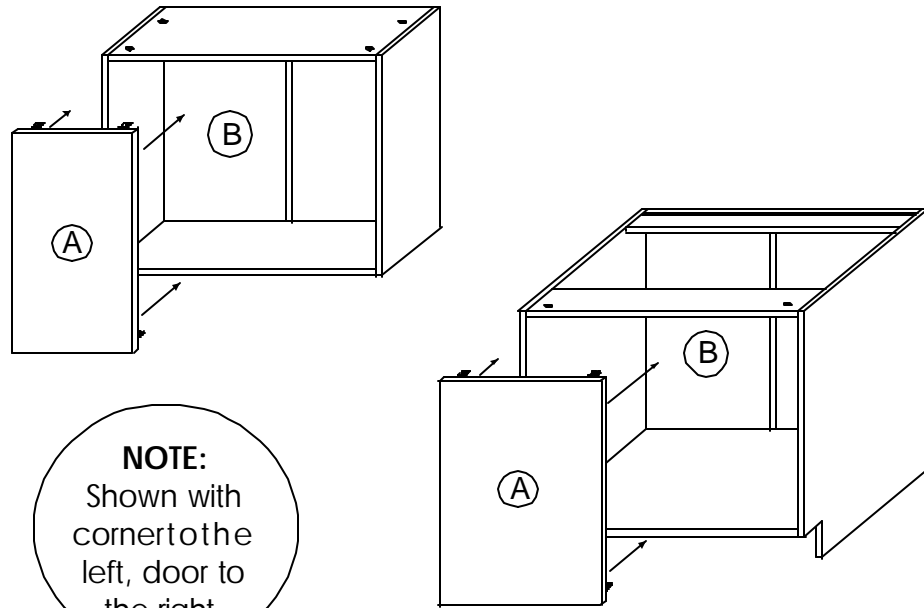

NOTE:
Shown with corner to the left, door to the right.

6

 x 4

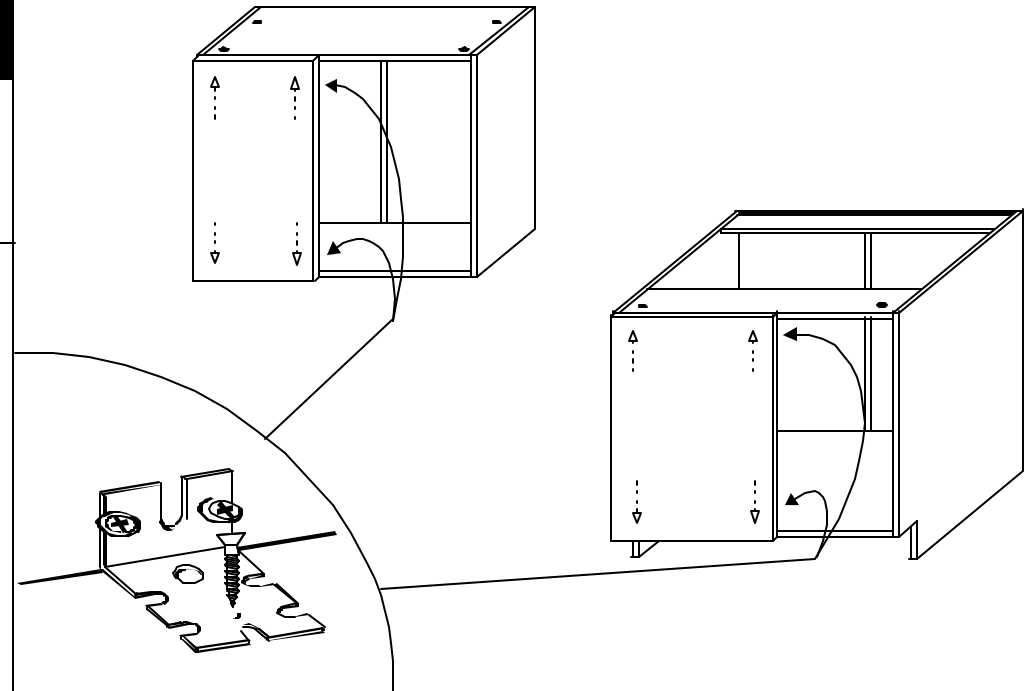

7

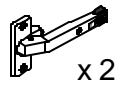
 x 2

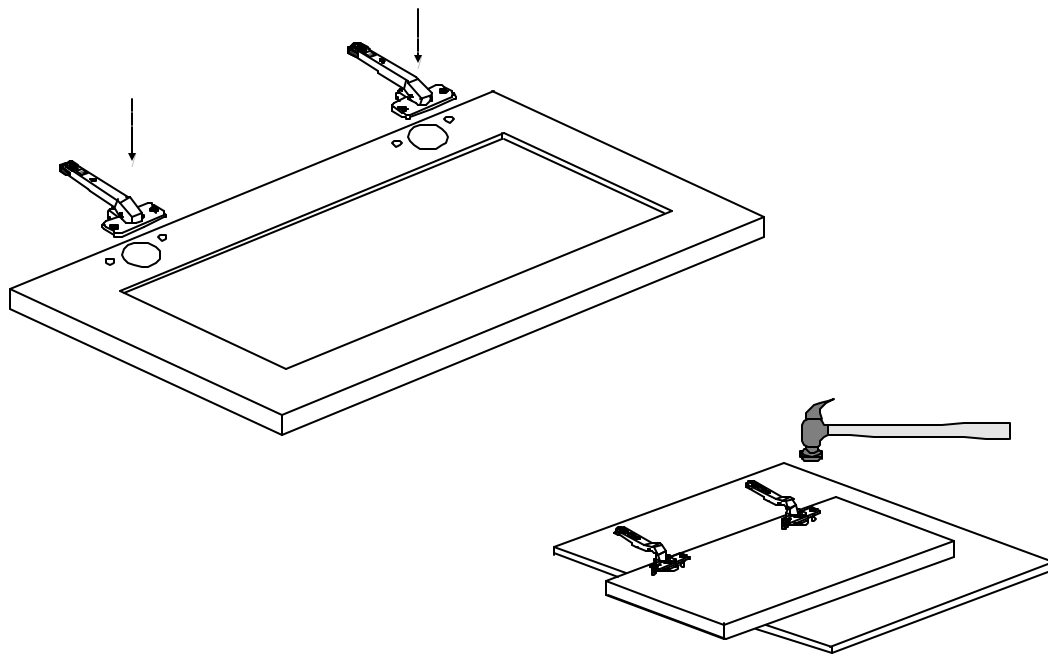

8

