



1610 Industrial Avenue
 Port Coquitlam BC V3C 6N3
 Phone: (604) 464-5060 Fax: (604) 464-7210

Order	ORD135855
Date	2/17/2009
Page	1

ORDER ACKNOWLEDGEMENT

Bill To:

RICK NUNES
 1610 Industrial Ave
 Port Coquitlam BC V3C 6N3

Ship To:

RICK NUNES
 1610 Industrial Ave
 Port Coquitlam BC V3C 6N3

BILLING ADDRESS

OUR ORDER #

SHIP TO ADDRESS

YOUR PO #

PAYMENT TERMS

QUANTITY ORDERED

SHIP DATE

ITEM CODE

DEALER COST (NOT LIST PRICE)

ITEM DESCRIPTION

SHIPPING INSTRUCTIONS

Purchase Order No.	Customer ID	Salesperson ID	Shipping Method	Payment Terms	Shipment Date	Master No.	
RN12345	RN	RN			2/17/2009	22,169	
Ordered	Shipped	B/C	Item Number	Description	Discount	Unit Price	Ext. Price
1	1	0	CW2442	24W X 42H CORNER WALL CAB	\$ 0.00	\$ 280.00	\$ 280.00
1	1	0	W3342	33W X 42H WALL CABINET	\$ 0.00	\$ 110.00	\$ 110.00
1	1	0	W3042	30W X 42H WALL CABINET	\$ 0.00	\$ 105.00	\$ 105.00
1	1	0	W3024	30W X 24H WALL CABINET	\$ 0.00	\$ 75.00	\$ 75.00
1	1	0	W2442	24W X 42H WALL CABINET	\$ 0.00	\$ 95.00	\$ 95.00
1	1	0	AW331524-W	33W X 15H X 24D WALL WHT	\$ 0.00	\$ 125.00	\$ 125.00
1	1	0	MW3042-W	30W X 42H MICROWV WALL W	\$ 0.00	\$ 145.00	\$ 145.00
1	1	0	3342R	33W X 42H DR PK SAN JUAN	\$ 0.00	\$ 280.00	\$ 280.00
1	1	0	3042R	30W X 42H DR PK SAN JUAN	\$ 0.00	\$ 240.00	\$ 240.00
1	1	0	3024R	30W X 24H DR PK SAN JUAN	\$ 0.00	\$ 140.00	\$ 140.00
1	1	0	3024R	30W X 24H DR PK SAN JUAN	\$ 0.00	\$ 140.00	\$ 140.00
1	1	0	2442R	24W X 42H DR PK SAN JUAN	\$ 0.00	\$ 225.00	\$ 225.00
1	1	0	2442R	24W X 42H DR PK SAN JUAN	\$ 0.00	\$ 225.00	\$ 225.00
1	1	0	2442CR	24W X 42H CHR DR SAN JUAN	\$ 0.00	\$ 180.00	\$ 180.00
1	1	0	3315R	33W X 15H DR PK SAN JUAN	\$ 0.00	\$ 120.00	\$ 120.00
						Subtotal	\$ 2,220.00
						Misc	\$ 0.00
						Tax	\$ 208.40
						Freight	\$ 0.00
						Trade Discount	\$ 0.00
						Total	\$ 2,428.40

TAG-JONESAW
 SHIP VIA OVERLAND FREIGHT
 COLLECT

THANK YOU FOR YOUR ORDER.
 CHANGES ARE NOT ACCEPTED ON ORDERS WITHOUT PENALTY

How to Order

The following pages will explain in full detail the steps to request a quote and place an order.

It's simple and we're here to help!

REQUESTING A QUOTE

SEND US YOUR REQUEST FOR A QUOTE:

Fax Measurement / List to: 1-604-464-7210 -or-
1-888-333-7210
Or Email Measurement / List to: orders@eurorite.com

GUIDELINES FOR REQUESTING A QUOTE

- A quotation document will be returned to the store within 24 hours.
- Quotes done in 20:20 are in LIST PRICE. Prices listed on Euro-Rite's "Order Quotation" document are at your cost after your multiplier has been applied.
- Review your quote. Send changes / revisions back to Euro-Rite Cabinets written directly on the quote pages sent to you. Revisions will be made and a second quote will be sent back to the store for approval.
- Once the quote is approved and when you decide to place an order for the items quoted, see our "2-Step Order Process" page.
- All quotes will remain in Euro-Rite's system for 60 days. After 60 days the quote will be deleted from our system.
- Quotes are not a commitment to purchase. Ship dates will not be assigned to any quote. Ship dates are assigned to committed orders only.
- Any document sent to Euro-Rite with a purchase order number on it will be deemed a committed order and will be processed as an order (See our "2-Step Order Process" page.)

****IMPORTANT****

Store purchase orders MUST contain Euro-Rite's product codes to be processed.

OUR 2-STEP ORDER PROCESS

1. SEND US YOUR PURCHASE ORDER:

Fax Order to: 1-604-464-7210 -or-
1-888-333-7210
Or Email Order to: orders@eurorite.com

2. CHECK YOUR ORDER ACKNOWLEDGEMENT SENT BACK TO YOU.

A **SHIP DATE** will be assigned to the order at this stage, based on Euro-Rite's product lead times.

****IMPORTANT****

If you do not receive an order acknowledgement within 24 hours of sending in your purchase order, contact Euro-Rite Cabinets' customer service toll-free 1-888-464-5063.

GUIDELINES FOR PLACING AN ORDER

- Orders must have a store purchase order, otherwise they will be treated as quotes. (See "Requesting a Quote" page.)
- Orders must contain Euro-Rite Cabinets' product codes or they will be treated as quotes. (See "Requesting a Quote" page.)
- It is our goal to enter orders into the system the same day they are received. Please note that delays may occur during high volume periods.
- Once the order is entered and an order acknowledgement is sent, you have 24 hours to make any corrections or unforeseen changes. Please fax or email revisions to the above numbers. Changes will affect the ship date.
- After the 24 hours period, the order will be in the production process and no changes will be accepted.
- Orders do not require a signed off copy to be sent back to Euro-Rite Cabinets.
- If combining orders to meet your prepaid limit, the ship date will always be set by the date of the last order placed (longest lead time).

For example: If your prepaid amount is \$1500.00:

PO 1234 Placed Today = \$1240.00 San Juan (1 Week)
PO 5678 Placed Today = \$750.00 Solaire CP (4 Weeks)

Both orders ship in 4 weeks.

WHO TO CALL

CHANGES TO DESIGNS/QUOTES

- QUESTIONS ON PRICING

SALES DIRECT

1-604-464-3477
1-888-412-3477

CHANGES TO ORDER ACKNOWLEDGMENTS

(WITHIN 24 HOURS)

CUSTOMER SERVICE

1-604-464-5060
1-888-464-5063

TRACK THE STATUS OF AN ORDER

CUSTOMER SERVICE

1-604-464-5060
1-888-464-5063

SHIPPING ISSUES

- FREIGHT DAMAGE
- WARRANTY CLAIMS

CUSTOMER SERVICE

1-604-464-5060
1-888-464-5063

ACCOUNT INFORMATION

- SHIPPING TERMS
- PRICE MULTIPLIER
- CHANGES TO ACCOUNT

SALES DIRECT

1-604-464-3477
1-888-412-3477

BILLING

- STATEMENTS
- INVOICE CORRECTIONS

ACCOUNTS RECEIVABLE

1-604-464-5060
1-888-464-5063

ORDER FORM

Date _____
 Store/Dealer _____
 Contact Person _____
 P.O.: _____

Tag: _____
 Shipping Info _____
 Door Style _____

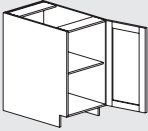
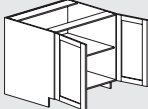
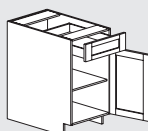
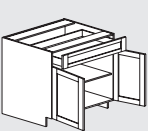
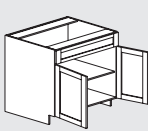
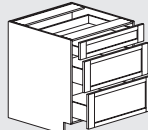
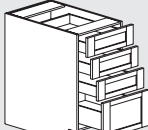

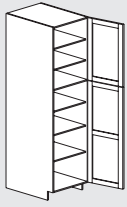
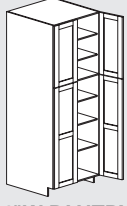
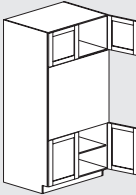
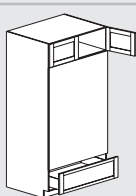
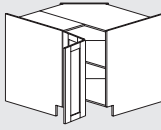

BASE CABINETS	Cross Members	Qty	Gable Pack	Qty	Door Pack	Qty
 1 DOOR	B09	___	BG-___	___	D0930	___
	B12	___	BG-___	___	D1230	___
	B15	___	BG-___	___	D1530	___
	B18	___	BG-___	___	D1830	___
	B21	___	BG-___	___	D2130	___
 2 DOORS	B24	___	BG-___	___	D2430	___
	B27	___	BG-___	___	D2730	___
	B30	___	BG-___	___	D3030	___
	B33	___	BG-___	___	D3330	___
 1 DOOR 1 DRAWER	BD12	___	BG-___	___	D12D	___
	BD15	___	BG-___	___	D15D	___
	BD18	___	BG-___	___	D18D	___
	BD21	___	BG-___	___	D21D	___
 2 DOORS 1 DRAWER	BD24	___	BG-___	___	D24D	___
	BD27	___	BG-___	___	D27D	___
	BD30	___	BG-___	___	D30D	___
	BD33	___	BG-___	___	D33D	___
	BD36	___	BG-___	___	D36D	___
 2 DOORS SINK FACE	B30	___	BG-___	___	D30D	___
	B33	___	BG-___	___	D33D	___
	B36	___	BG-___	___	D36D	___
 3 DRAWER POTS & PANS BANK	PB24	___	BG-___	___	D24PB	___
	PB30	___	BG-___	___	D30PB	___
 4 DRAWER BANK	DB12	___	BG-___	___	D12DB	___
	DB15	___	BG-___	___	D15DB	___
	DB18	___	BG-___	___	D18DB	___

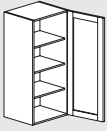
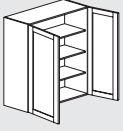

TALL CABINETS	Cross Members	Qty	Gable Pack	Qty	Door Pack	Qty
 18"W PANTRY	84"H, 90"H					
	P1824	___	PG84-___	___	D1884P	___
	P1824	___	PG90-___	___	D1890P	___
	95"H (REQUIRES EXTENSION KITS)					
	P1824	___	PG84-___	___	D1895P	___
	PE1824	___			<- (EXTENSION KIT)	
	WG1224-	___			<- (EXTENSION KIT)	
 24"W PANTRY	84" & 90" TALL					
	P2424	___	PG84-___	___	D2484P	___
	P2424	___	PG90-___	___	D2490P	___
	95"H (REQUIRES EXTENSION KITS)					
	P2424	___	PG84-___	___	D2495P	___
	PE2424	___			<- (EXTENSION KIT)	
	WG1224-	___			<- (EXTENSION KIT)	
 WALL OVEN	84" & 90" TALL					
	WO33	___	OG84-___	___	D3384WO	___
	WO33	___	OG90-___	___	D3390WO	___
	95"H (REQUIRES EXTENSION KITS)					
	WO33	___	OG84-___	___	D3395WO	___
	AW3324	___			<- (EXTENSION KIT)	
	WG1224-	___			<- (EXTENSION KIT)	
 MICROWAVE WALL OVEN	84" & 90" TALL					
	MWO33	___	OG84-___	___	D3384MWO	___
	MWO33	___	OG90-___	___	D3390MWO	___
	95"H (REQUIRES EXTENSION KITS)					
	MWO33	___	OG84-___	___	D3395MWO	___
	AW3324	___			<- (EXTENSION KIT)	
	WG1224-	___			<- (EXTENSION KIT)	
 STANDARD CORNER	CORNER BASE CABINETS					
	CCB3333	___	BCG-___	___	D3333C	___
	CCB3636	___	BCG-___	___	D3636C	___
* For Non-Standard Corners, see page 8.7						

ORDER FORM

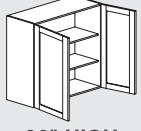
Date _____
 Store/Dealer _____
 Contact Person _____
 P.O.: _____

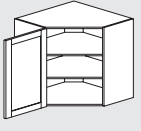
Tag: _____
 Shipping Info _____
 Door Style _____

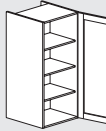
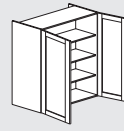
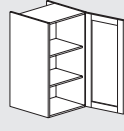
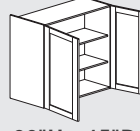
WALL CABINETS	Cross Members	Qty	Gable Pack	Qty	Door Pack	Qty
 42" HIGH 1 DOOR	WT09	___	WG42-__	___	D0942__	___
	WT12	___	WG42-__	___	D1242__	___
	WT15	___	WG42-__	___	D1542__	___
	WT18	___	WG42-__	___	D1842__	___
	WT21	___	WG42-__	___	D2142__	___
 42" HIGH 2 DOORS	WT24	___	WG42-__	___	D2442__	___
	WT27	___	WG42-__	___	D2742__	___
	WT30	___	WG42-__	___	D3042__	___
	WT33	___	WG42-__	___	D3342__	___
	WT36	___	WG42-__	___	D4242__	___
 36" HIGH 1 DOOR	W09	___	WG36-__	___	D0936__	___
	W12	___	WG36-__	___	D1236__	___
	W15	___	WG36-__	___	D1536__	___
	W18	___	WG36-__	___	D1836__	___
	W21	___	WG36-__	___	D2136__	___
 36" HIGH 2 DOORS	W24	___	WG36-__	___	D2436__	___
	W27	___	WG36-__	___	D2736__	___
	W30	___	WG36-__	___	D3036__	___
	W33	___	WG36-__	___	D3336__	___
	W36	___	WG36-__	___	D3636__	___
 30" HIGH 1 DOOR	W09	___	WG30-__	___	D0930__	___
	W12	___	WG30-__	___	D1230__	___
	W15	___	WG30-__	___	D1530__	___
	W18	___	WG30-__	___	D1830__	___
	W21	___	WG30-__	___	D2130__	___
 30" HIGH 2 DOORS	W24	___	WG30-__	___	D2430__	___
	W27	___	WG30-__	___	D2730__	___
	W30	___	WG30-__	___	D3030__	___
	W33	___	WG30-__	___	D3330__	___
	W36	___	WG30-__	___	D3630__	___
 CORNER WALL 30"H SHOWN HERE	DCW2142	___	WG42-__	___	D2142C__	___
	DCW2442	___	WG42-__	___	D2442C__	___
	DCW2136	___	WG36-__	___	D2136C__	___
	DCW2436	___	WG36-__	___	D2436C__	___
	DCW2130	___	WG30-__	___	D2130C__	___
	DCW2430	___	WG30-__	___	D2430C__	___

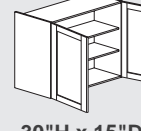
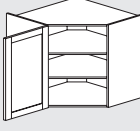



WALL CABINETS	Cross Members	Qty	Gable Pack	Qty	Door Pack	Qty
 42" H x 15" D 1 DOOR	WT09	___	WG4215-__	___	D0942__	___
	WT12	___	WG4215-__	___	D1242__	___
	WT15	___	WG4215-__	___	D1542__	___
	WT18	___	WG4215-__	___	D1842__	___
	WT21	___	WG4215-__	___	D2142__	___
 42" H x 15" D 2 DOORS	WT24	___	WG4215-__	___	D2442__	___
	WT27	___	WG4215-__	___	D2742__	___
	WT30	___	WG4215-__	___	D3042__	___
	WT33	___	WG4215-__	___	D3342__	___
	WT42	___	WG4215-__	___	D3642__	___
 36" H x 15" D 1 DOOR	W09	___	WG3615-__	___	D0936__	___
	W12	___	WG3615-__	___	D1236__	___
	W15	___	WG3615-__	___	D1536__	___
	W18	___	WG3615-__	___	D1836__	___
	W21	___	WG3615-__	___	D2136__	___
 36" H x 15" D 2 DOORS	W24	___	WG3615-__	___	D2436__	___
	W27	___	WG3615-__	___	D2736__	___
	W30	___	WG3615-__	___	D3036__	___
	W33	___	WG3615-__	___	D3336__	___
	W36	___	WG3615-__	___	D3636__	___
 30" H x 15" D 1 DOOR	W09	___	WG3015-__	___	D0930__	___
	W12	___	WG3015-__	___	D1230__	___
	W15	___	WG3015-__	___	D1530__	___
	W18	___	WG3015-__	___	D1830__	___
	W21	___	WG3015-__	___	D2130__	___
 30" H x 15" D 2 DOORS	W24	___	WG3015-__	___	D2430__	___
	W27	___	WG3015-__	___	D2730__	___
	W30	___	WG3015-__	___	D3030__	___
	W33	___	WG3015-__	___	D3330__	___
	W36	___	WG3015-__	___	D3630__	___
 CORNER WALL 15" D 30" H SHOWN HERE	DCW2142	___	WG4215-__	___	D2142C__	___
	DCW2442	___	WG4215-__	___	D2442C__	___
	DCW2136	___	WG3615-__	___	D2136C__	___
	DCW2436	___	WG3615-__	___	D2436C__	___
	DCW2130	___	WG3015-__	___	D2130C__	___
	DCW2430	___	WG3015-__	___	D2430C__	___

ORDER FORM

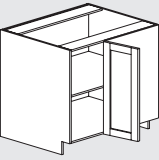
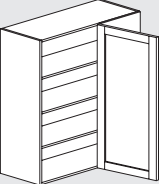
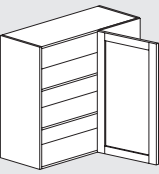
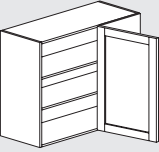
Date _____
 Store/Dealer _____
 Contact Person _____
 P.O.: _____

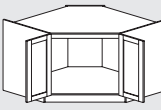
Tag: _____
 Shipping Info _____
 Door Style _____

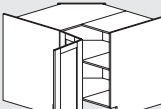
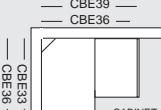
CABINETS	Cross Members	Qty	Gable Pack	Qty	Door Pack	Qty
 BLIND BASE	B27	___	BG-__	___	D0930_	___
	PANEL KIT -->		BBP-__	___		
	B30	___	BG-__	___	D1230_	___
	PANEL KIT -->		BBP-__	___		
	B33	___	BG-__	___	D1530_	___
 42" HIGH BLIND WALL	W21	___	WG42-__	___	D0942_	___
	PANEL KIT -->		BWP42-__	___		
	W24	___	WG42-__	___	D1242_	___
	PANEL KIT -->		BWP42-__	___		
	W27	___	WG42-__	___	D1542_	___
 36" HIGH BLIND WALL	W21	___	WG36-__	___	D0936_	___
	PANEL KIT -->		BWP36-__	___		
	W24	___	WG36-__	___	D1236_	___
	PANEL KIT -->		BWP36-__	___		
	W27	___	WG36-__	___	D1536_	___
 30" HIGH BLIND WALL	W21	___	WG30-__	___	D0930_	___
	PANEL KIT -->		BWP30-__	___		
	W24	___	WG30-__	___	D1230_	___
	PANEL KIT -->		BWP30-__	___		
	W27	___	WG30-__	___	D1530_	___

CABINETS	Cross Members	Qty	Gable Pack	Qty	Door Pack	Qty
 CORNER SINK BASE	DSB42	___	BCG-__	___	D42CS_	___
 DIAGONAL CORNER BASE	DCB36	___	BCG-__	___	D36CD_	___
 CORNER SINK BASE	33x36 (reversible assembly)					
	CCB3333	___	BCG-__	___	D3336C_	___
	CBE36	___			<- (EXTENSION KIT)	
 CORNER SINK BASE	33x39 (reversible assembly)					
	CCB3333	___	BCG-__	___	D3339C_	___
	CBE39	___			<- (EXTENSION KIT)	
 CORNER SINK BASE	33x36 (reversible assembly)					
	CCB3639	___	BCG-__	___	D3639C_	___
	CBE36	___			<- (EXTENSION KIT)	

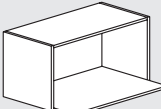
MICROWAVE CABINET	Code	Qty
 24"W	MW2415-	___
	MW2418-	___
30"W	MW3015-	___
	MW3018-	___



NOTE:
 Euro-Rite has developed a unique system for any microwave configuration. The MW cabinet itself has an extended bottom shelf and no doors. It houses your microwave and can be paired with any cabinet for maximum flexibility. Our microwave cabinet comes in a single box and is colour matched.

ORDER FORM

Date _____
 Store/Dealer _____
 Contact Person _____
 P.O.: _____

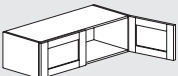
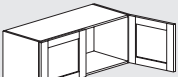
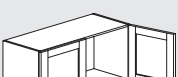
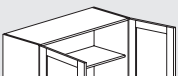
Tag: _____
 Shipping Info _____
 Door Style _____

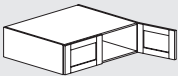
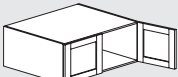
STANDARD APPLIANCE	Cross Members	Qty	Gable Pack	Qty	Door Pack	Qty
	AW30	___	WG12-__	___	D3012_	___
	AW33	___	WG12-__	___	D3312_	___
	AW36	___	WG12-__	___	D3612_	___
12" H						
	AW24	___	WG15-__	___	D2415_	___
	AW30	___	WG15-__	___	D3015_	___
	AW33	___	WG15-__	___	D3315_	___
	AW36	___	WG15-__	___	D3615_	___
15" H						
	AW24	___	WG18-__	___	D2418_	___
	AW30	___	WG18-__	___	D3018_	___
	AW33	___	WG18-__	___	D3318_	___
	AW36	___	WG18-__	___	D3618_	___
18" H						
	W24	___	WG24-__	___	D2424_	___
	W30	___	WG24-__	___	D3024_	___
	W33	___	WG24-__	___	D3324_	___
	W36	___	WG24-__	___	D3624_	___
24" H						

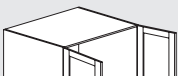
DEEP APPLIANCE	Cross Members	Qty	Gable Pack	Qty	Door Pack	Qty
	AW3024	___	WG1224-__	___	D3012_	___
	AW3324	___	WG1224-__	___	D3312_	___
	AW3624	___	WG1224-__	___	D3612_	___
12"H x 24"D						
	AW3024	___	WG1524-__	___	D3015_	___
	AW3324	___	WG1524-__	___	D3315_	___
	AW3624	___	WG1524-__	___	D3615_	___
15"H x 24"D						
	AW3024	___	WG1824-__	___	D3018_	___
	AW3324	___	WG1824-__	___	D3318_	___
	AW3624	___	WG1824-__	___	D3618_	___
18"H x 24"D						
	AW3024	___	WG2424-__	___	D3024_	___
	AW3324	___	WG2424-__	___	D3324_	___
	AW3624	___	WG2424-__	___	D3624_	___
24"H x 24"D						



ORDER FORM

Date _____ Tag: _____
 Store/Dealer _____ Shipping Info _____
 Contact Person _____
 P.O.: _____ Door Style _____

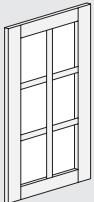
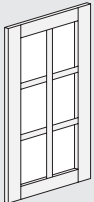
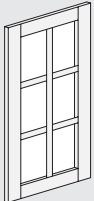
GLASS DOOR OPTIONS

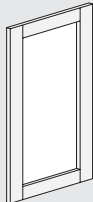
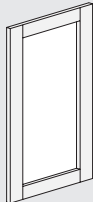
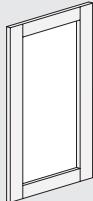
MULLION DOOR	
<i>AVAILABLE IN:</i> San Juan, Saltspring, Bowen, Cortes, Rainier, Cascade, Santos & Solaire White (Does not include glass.)	
Code	Qty
	D1242M _____ D1542M _____ D1842M _____ D2442M _____ D3042M _____ D3642M _____ D2142CM _____ D2442CM _____
42"H MULLION	
	D1236M _____ D1536M _____ D1836M _____ D2436M _____ D3036M _____ D3636M _____ D2136CM _____ D2436CM _____
36"H MULLION	
	D1230M _____ D1530M _____ D1830M _____ D2430M _____ D3030M _____ D3630M _____ D2130CM _____ D2430CM _____
30"H MULLION	

OPEN FRAME	
<i>AVAILABLE IN:</i> Saltspring, Bowen, Cortes, Rainier, Cascade, Cyprus, Santos, Solaire (Does not include glass.)	
Code	Qty
	D1242OF _____ D1542OF _____ D1842OF _____ D2442OF _____ D3042OF _____ D3642OF _____ D2142COF _____ D2442COF _____
42"H OPEN FRAME	
	D1236OF _____ D1536OF _____ D1836OF _____ D2436OF _____ D3036OF _____ D3636OF _____ D2136COF _____ D2436COF _____
36"H OPEN FRAME	
	D1230OF _____ D1530OF _____ D1830OF _____ D2430OF _____ D3030OF _____ D3636OF _____ D2130COF _____ D2430COF _____
30"H OPEN FRAME	

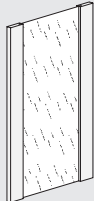
GLASS PANEL	
<i>AVAILABLE IN:</i> Acadia Beech, Light Honey, Pearwood, Fusion Maple, Chocolate Pear & Oxford White (Comes with glass.)	
Code	Qty
	D1242G _____ D1542G _____ D1842G _____ D2442G _____ D3042G _____ D3642G _____ D2142CG _____ D2442CG _____
42"H GLASS PANEL	
	D1236G _____ D1536G _____ D1836G _____ D2436G _____ D3036G _____ D3636G _____ D2136CG _____ D2436CG _____
36"H GLASS PANEL	
	D1230G _____ D1530G _____ D1830G _____ D2430G _____ D3030G _____ D3630G _____ D2130CG _____ D2430CG _____
30"H GLASS PANEL	

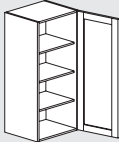
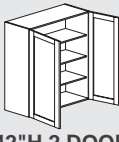

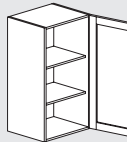
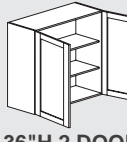

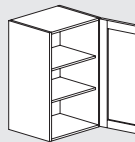
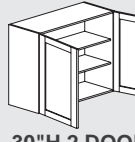
COLOUR CABINETS	
Code	Qty
	W1242- _____ W1542- _____ W1842- _____ W2442- _____ W3042- _____ W3642- _____
42"H 1 DOOR	
	CW2142- _____ CW2442- _____ CW214215- _____ CW244215- _____
42"H 2 DOOR	

COLOUR CABINETS	
Code	Qty
	W1236- _____ W1536- _____ W1836- _____ W2436- _____ W3036- _____ W3636- _____
36"H 1 DOOR	
	CW2136- _____ CW2436- _____ CW213615- _____ CW243615- _____
36"H 2 DOOR	

COLOUR CABINETS	
Code	Qty
	W1230- _____ W1530- _____ W1830- _____ W2430- _____ W3030- _____ W3630- _____
30"H 1 DOOR	
	CW2130- _____ CW2430- _____ CW213015- _____ CW243015- _____
30"H 2 DOOR	

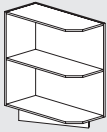
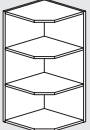
ORDER FORM

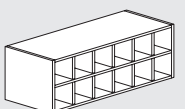
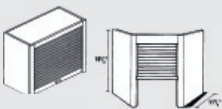
Date _____ Tag: _____
 Store/Dealer _____ Shipping Info _____
 Contact Person _____
 P.O.: _____ Door Style _____

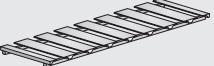
ACCESSORIES	Code	Qty	ACCESSORIES	Code	Qty
 BASE DIAGONAL END	BDE-__	_____	OTHER		
 BASE WINE RACK	WDE30-__ WDE36-__ WDE42-__	_____ _____ _____	30"H PENNINSULA ISLAND BACK	PIB-__	_____
 BASE WINE RACK	BWR-__	_____	42"H PENNINSULA ISLAND BACK	PIB42-__	_____
 BASE WINE RACK	WR-__	_____	COUNTERTOP BRACKET	CTB-__	_____
 APPLIANCE GARAGE	AG-__ CG-__	_____ _____	INSTALLATION SCREW KIT	INS	_____
 PENCIL DRAWER	PD30__	_____	SINK BRACKET KIT	SKB	_____
 PLATE RACK	PR3030-__	_____	18"W PULL OUT DRAWER	POD18	_____
 STEMWARE HOLDER	WGH-__	_____	24"W PULL OUT DRAWER	POD24	_____
			30"W PULL OUT DRAWER	POD30	_____
			25' EDGE TAPE ROLL	ET-__	_____
			TOUCH UP KIT (CP,WC,S)	TUKIT-__	_____
			REV-A-SHELF		
			15"W CUTLERY TRAY	CT15RAS	_____
			18"W CUTLERY TRAY	CT18RAS	_____
			21"W CUTLERY TRAY	CT21RAS	_____
			24"W CUTLERY TRAY	CT24RAS	_____
			15"W WOOD CUTLERY TRAY	CTWOOD15RAS	_____
			21"W WOOD CUTLERY TRAY	CTWOOD21RAS	_____
			ROLL OUT CUTLERY TRAY	CTRORAS	_____
			15"W UTENSIL TRAY	UT15RAS	_____
			18"W UTENSIL TRAY	UT18RAS	_____
			21"W UTENSIL TRAY	UT21RAS	_____
			24"W UTENSIL TRAY	UT24RAS	_____
			15 5/8"W SPICE TRAY	SP15RAS	_____
			SINK TIP OUT TRAY	SUTRAS	_____
			TOWEL HOLDER WHITE	TH3WRAS	_____
			TOWEL HOLDER CHROME	TH3CRAS	_____
			LAZY SUSAN FOR 33CB	LS33RAS	_____
			LAZY SUSAN FOR 36CB	LS36RAS	_____
			12" TRAY DIVIDER WHITE	TD12WRAS	_____
			18" TRAY DIVIDER WHITE	TD18WRAS	_____
			12" TRAY DIVIDER CHROME	TD12CRAS	_____
			18" TRAY DIVIDER CHROME	TD18CRAS	_____
			28QT PULL OUT GARBAGE CAN	GC28PORAS	_____
			27QT RECYCLING BINS (2)	REC15WHRAS	_____
			15QT RECYCLING BINS (2)	REC12RAS	_____
			27QT WOOD RECYCLING SYSTEM (4)	REC24WDRAS	_____
			13L SWING OUT GARBAGE CAN	GC13SORAS	_____
			10L IN COUNTER BIN	GCIB11RAS	_____
			BLIND CORNER OPTIMISER LEFT	BCOLRAS	_____
			BLIND CORNER OPTIMISER RIGHT	BCORRAS	_____
			6"W BASE FILLER CABINET	BASFCRAS	_____
			6" BASE FILLER CABINET FRONT PANEL	BPF-__	_____
			18"W BASE CABINET PULL OUT	BASPO18RAS	_____
			24"W BASE CABINET PULL OUT	BASPO24RAS	_____
			18"W PANTRY CABINET PULL OUT	PANPO18RAS	_____
			24"W PANTRY CABINET PULL OUT	PANPO24RAS	_____
			HEAVY DUTY APPLIANCE LIFTER	HDLIFTRAS	_____
			24"W COOKWARE PULL OUT	COOKPORAS	_____

ORDER FORM

Date _____ Tag: _____
 Store/Dealer _____ Shipping Info _____
 Contact Person _____
 P.O.: _____ Door Style _____

CABINET PARTS	Code	Qty
GABLES		
DESK END	DG-__	_____
DISHWASHER END	DW35-__	_____
84"H X 12"D FRIDGE END	FR8412-__	_____
84"H X 24"D FRIDGE END	FR8424-__	_____
90"H X 12"D FRIDGE END	FR9012-__	_____
90"H X 24"D FRIDGE END	FR9024-__	_____
95"H X 12"D FRIDGE END	FR9512-__	_____
95"H X 24"D FRIDGE END	FR9524-__	_____
30"H DIAGONAL END GABLE	DC30-__	_____
36"H DIAGONAL END GABLE	DC36-__	_____
42"H DIAGONAL END GABLE	DC42-__	_____
MOULDINGS/FILLER STRIPS/TOE KICKS		
108"L CROWN MOULDING	CM-__	_____
108"L SHAKER MOULDING	CMS-__	_____
96"L DENTIL MOULDING	DM-__	_____
96"L ROPE MOULDING	RM-__	_____
42"L INSIDE MOULDING	IM-__	_____
42"L OUTSIDE MOULDING	OM-__	_____
42"L BUTT MOULDING	BM-__	_____
42"L FLUTED FILLER	FF-__	_____
ROSETTES 2/PK	RS-__	_____
48"L STRAIGHT VALANCE	V48-__	_____
96"L PROFILED LIGHT VALANCE	PV-__	_____
30 5/8"L FILLER STRIP	FS330-__	_____
41 1/2"L FILLER STRIP	FS342-__	_____
90 7/8"L FILLER STRIP	F391-__	_____
96"L TOE KICK	TK96-__	_____
48"L TOE KICK	TK48-__	_____
SHELF PACKS		
9"W WALL SHELF PACK 2/PK	SHPKW-9	_____
12"W WALL SHELF PACK 2/PK	SHPKW-12	_____
15"W WALL SHELF PACK 2/PK	SHPKW-15	_____
18"W WALL SHELF PACK 2/PK	SHPKW-18	_____
21"W WALL SHELF PACK 2/PK	SHPKW-21	_____
24"W WALL SHELF PACK 2/PK	SHPKW-24	_____
27"W WALL SHELF PACK 2/PK	SHPKW-27	_____
30"W WALL SHELF PACK 2/PK	SHPKW-30	_____
33"W WALL SHELF PACK 2/PK	SHPKW-33	_____
36"W WALL SHELF PACK 2/PK	SHPKW-36	_____
9"W BASE SHELF PACK 1/PK	SHPKB-9	_____
12"W BASE SHELF PACK 1/PK	SHPKB-12	_____
15"W BASE SHELF PACK 1/PK	SHPKB-15	_____
18"W BASE SHELF PACK 1/PK	SHPKB-18	_____
21"W BASE SHELF PACK 1/PK	SHPKB-21	_____
24"W BASE SHELF PACK 1/PK	SHPKB-24	_____
27"W BASE SHELF PACK 1/PK	SHPKB-27	_____
30"W BASE SHELF PACK 1/PK	SHPKB-30	_____
33"W BASE SHELF PACK 1/PK	SHPKB-33	_____
36"W BASE SHELF PACK 1/PK	SHPKB-36	_____

HARDWARE	Code	Qty
KNOBS & PULLS		
1 1/4 ROUND KNOB BRASS	KNBRB	_____
1 1/4 ROUND KNOB CHROME	KNBRC	_____
1 1/4 ROUND KNOB BRUSHED CHROME	KNBRBC	_____
1 1/4 ROUND KNOB BLACK	KNBRBLK	_____
1 1/4 ROUND KNOB MATTE NICKEL	KNBRMN	_____
1 1/4 ROUND KNOB BLACK NICKEL	KNBRBN	_____
1 1/4 MUSHROOM KNOB BRSH CHROME	KNBMBC	_____
1 1/4 MUSHROOM WEATHER SILVER	KNBMWS	_____
1 1/4 MUSHROOM WEATHER BLACK	KNBMWB	_____
1 1/4 DISH KNOB SANTE FE NICKEL	KNBDSFN	_____
3 3/4 BOW PULL POLISHED BRASS	PULB375B	_____
3 3/4 BOW PULL POLISHED CHROME	PULB375C	_____
3 3/4 BOW PULL MATTE NICKEL	PULB375MN	_____
3 3/4 BOW PULL BLACK NICKEL	PULB375NB	_____
3 3/4 BOW PULL MATTE BLACK	PULB375MB	_____
3 3/4 BOW PULL WEATHER SILVER	PULB375WS	_____
3 3/4 BOW PULL WEATHER BLACK	PULB375WB	_____
3 3/4 D PULL POLISHED BRASS	PULD375B	_____
3 3/4 D PULL POLISHED CHROME	PULD375C	_____
3 3/4 D PULL BRUSHED CHROME	PULD375BC	_____
3 3/4 D PULL MATTE NICKEL	PULD375MN	_____
3 3/4 D PULL BLACK NICKEL	PULD375NB	_____
5 BEECH BAR SATIN NICKEL	PULS5BBSN	_____
METABOX		
85 X 400 METABOX STD SLIDE PACK	SLDMETA400S	_____
85 X 500 METABOX STD SLIDE PACK	SLDMETA500S	_____
149 X 400 METABOX STD SLIDE PACK	SLDMETA400H	_____
149 X 500 METABOX STD SLIDE PACK	SLDMETA500H	_____
53 X 500 INTEG NRW SLIDE PACK	SLDI500N	_____
INTEG PRESS BRACKET NRW LH	BRKTINLH	_____
INTEG PRESS BRACKET NRW RH	BRKTINRH	_____
META BRACKET RTA LH	BRKTMETARTALH	_____
META BRACKET RTA RH	BRKTMETARTARH	_____
HINGES & MOUNTING PLATES		
110 DEG CLIP ON HINGE 2/PK	HINF110C-2	_____
45 DEG CLIP ON HINGE 2/PK	HINF45C-2	_____
90 DEG FLIP ON HINGE 2/PK	HINF90C-2	_____
CLIP ON PLATE FERRARI 2/PK	PLTFC-2	_____
165 DEG CORNER HINGE 2PK	HINS165S-2	_____
PIE CORNER HINGE 2/PK	HINSPIES-2	_____
STD MOUNTING PLATE SALICE 2/PK	PLTSS-2	_____



ORDER FORM

Date _____ Tag: _____
 Store/Dealer _____ Shipping Info _____
 Contact Person _____
 P.O.: _____ Door Style _____

ACCESSORIES	Code	Qty
HARDWARE		
DOWEL METAL (50/pk)	F1-50	_____
DOWEL METAL DBL END (50/pk)	F13-50	_____
DOWEL WOODEN (100/pk)	F3-100	_____
DOWEL WOODEN PREGGLUE (50/pk)	F55-50	_____
DOWEL HINGE INSTALL (10/pk)	F61-10	_____
CAM METAL (50/pk)	F2-50	_____
SCREW CONFIRMAT 38mm (100/pk)	F5-50	_____
SCREW EURO 6.3x10 (100/pk)	F6-100	_____
SCREW EURO 6.3x13 (100/pk)	F10-100	_____
SCREW 8x1-1/8 FLAT HEAD (100/pk)	F7-100	_____
SCREW 8x1-1/4 FLAT HEAD (100/pk)	F8-100	_____
SCREW 8x3/4 FLAT HEAD (50/pk)	F31-50	_____
SCREW 6x5/8 FLAT HEAD (50/pk)	F19-50	_____
SCREW 1 1/4 ROUND HEAD (20/pk)	F28-20	_____
SCREW 1 3/4 ROUND HEAD (20/pk)	F29-20	_____
SCREW 2 1/2 INSTALL (50/pk)	F36-50	_____
SCREW BREAKAWAY (10/pk)	F63-10	_____
SCREW MULTI-HEAD 10mm (10/pk)	F67-10	_____
SCREW 7.5x10 EURO GOLD (10/pk)	F50-10	_____
WASHER #8 CUP (100/pk)	F9-100	_____
NAIL FINISHING (100/pk)	F12-100	_____
NAIL 1" COMMON (100/pk)	F14-100	_____
CONNECTOR BOLT MALE (20/pk)	F25-20	_____
CONNECTOR BOLT FEMALE (20/pk)	F26-20	_____
BRACKET 1" CORNER (10/pk)	F20-10	_____
BRACKET 45* CORNER (10/pk)	F21-10	_____
BRACKET SINK (10/pk)	F22-10	_____
BLUM FITTING WHITE (10/pk)	F17-10	_____
BLUM FITTING NYLON (10/pk)	F18-10	_____
SPACER NYLON 19mm (10/pk)	F11-10	_____
SHELF CLIP CLEAR 5mm (50/pk)	F4-50	_____
SHELF CLIP WINE RACK (20/pk)	F23-20	_____
SHELF SECURE CLIP (50/pk)	F56-50	_____
BUMPER CLEAR 5/16 (50/pk)	F15-50	_____
BUMPER CLEAR 1/2 (50/pk)	F16-50	_____
HINGE HOLE COVER TAN (10/pk)	F58-10	_____
CAM COVER CAP WHITE (100/pk)	F39-100	_____
SCREW COVER SNAPON (50/pk)	F37-50	_____
SCREW COVER PUSHIN (50/pk)	F38-50	_____
SCREW COVER CONFIRMAT (20/pk)	F44-20	_____
PULL D WHITE PLASTIC (10/pk)	F27-10	_____
DIVIDER 1/8 PLASTIC (20/pk)	F24-20	_____
LARGE PARTS BOX	LPARTS	_____
SMALL PARTS BOX	SPARTS	_____



POINT OF SALE MERCHANDISE	Code	Qty
SAMPLE DOORS		
SAMPLE DOOR-GABRIOLA	SD-H	_____
SAMPLE DOOR-SAN JUAN	SD-R	_____
SAMPLE DOOR-SALTSPRING	SD-FO	_____
SAMPLE DOOR-BOWEN	SD-RO	_____
SAMPLE DOOR-RAINIER	SD-RM	_____
SAMPLE DOOR-CASCADE	SD-RA	_____
SAMPLE DOOR-MONT ACADIA BEECH	SD-AB	_____
SAMPLE DOOR-MONT FUSION MAPLE	SD-FM	_____
SAMPLE DOOR-MONT OXFORD WHITE	SD-OW	_____
SAMPLE DOOR-MONT PEARWOOD	SD-PW	_____
SAMPLE DOOR-MONT LIGHT HEMLOCK	SD-LH	_____
SAMPLE DOOR-MONT CHOCOLATE PEAR	SD-CP	_____
SAMPLE DOOR-CYPRUS ALDER	SD-SA	_____
SAMPLE DOOR-CYPRUS MAPLE	SD-SM	_____
SAMPLE DOOR-CYPRUS CHOC PEAR	SD-SCPS	_____
SAMPLE DOOR-CYPRUS WILD CHERRY	SD-SWCS	_____
SAMPLE DOOR-CYPRUS SPICE	SD-SSS	_____
SAMPLE DOOR-SOLAIRE WHITE	SD-FPW	_____
SAMPLE DOOR-SOLAIRE CHOC PEAR	SD-FPCP	_____
SAMPLE DOOR-SOLAIRE WILD CHERRY	SD-FPWC	_____
SAMPLE DOOR-SOLAIRE ANTIQUE WHITE	SD-FPAW	_____
SAMPLE DOOR-SANTOS WHITE	SD-VW	_____
SAMPLE DOOR-CLOSET CHOC PEAR	SD-CCP	_____
SAMPLE DOOR-CLOSET ANTIQUE WHITE	SD-CAW	_____
POS MATERIAL/LITERATURE		
INSTORE SALES CATALOGUE (EACH)	POSCAT	_____
TEAR OFF PAD KITCHEN (50/PAD)	POSTOKIT	_____
TEAR OFF PAD BATHROOM (50/PAD)	POSTOBATH	_____
TEAR OFF PAD CLOSET (50/PAD)	POSTOCLOSET	_____
DESIGN GUIDE (100/PKG)	POSDG	_____
DESIGN GUIDE CLOSETS (100/PKG)	POSCLTF	_____
DOOR MERCHANDISER WALL UNIT	DMW24-RTA	_____
DOOR MERCHANDISER FULL UNIT	DMWB-RTA	_____
MERCHANDISER TAB SET- NATURAL WOOD	POSTABWDNAT	_____
MERCHANDISER TAB SET- STAINED WOOD	POSTABWDSTN	_____
MERCHANDISER TAB SET- LAMINATE	POSTABLAM	_____
MERCHANDISER TAB SET- THERMOFOIL	POSTABTF	_____
DOOR MERCHANDISER SIGN	POSSIGN530	_____

ORDER FORM

Date _____
 Store/Dealer _____
 Contact Person _____
 P.O.: _____

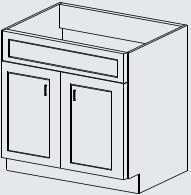
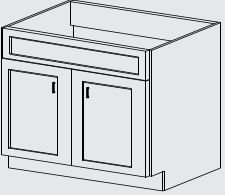
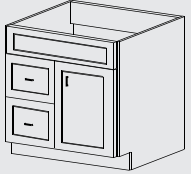
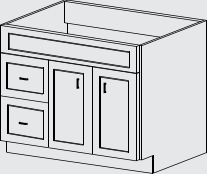
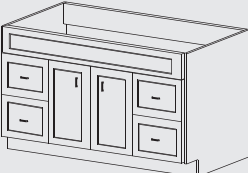
Tag: _____
 Shipping Info _____
 Door Style _____

VANITY CABINET	Code	Qty
 24"W SINK BASE	VS2418-__ VS2421-__	_____ _____
 30"W SINK BASE	VS3018-__ VS3021-__	_____ _____
 30"W DOOR / 2 DRAWER COMBO	VSD3018-2-__ VSD3021-2-__	_____ _____
 36"W DOOR / 2 DRAWER COMBO	VSD3618-2-__ VSD3621-2-__	_____ _____
 48"W DOOR / 4 DRAWER COMBO	VSD4818-4-__ VSD4821-4-__	_____ _____

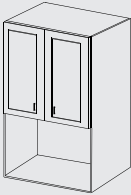
VANITY CABINET	Code	Qty
 3 DRAWER BANK (21"D only)	VD3-1221-__ VD3-1521-__	_____ _____
 LINEN TOWER W/DOORS ONLY	TL15-__ 1530__ (TOP) _____ 1530__ (BOTTOM) _____	_____ _____ _____
 LINEN TOWER W/DOORS & DRAWERS	TL15-__ 1530__ (TOP) _____ 1530__ (BOTTOM) _____ 15TLD3-__ _____	_____ _____ _____ _____
 OVERJOHN	OJ-__ _____	_____

NOTES ABOUT OUR VANITY PROGRAM:

- Not all vanity sizes are available in every door style. See page 3.5 for availability and price.
- Base vanities and overjohns are packaged in one box.
- Vanities do not come with backboard to allow for plumbing.
- Vanities are supplied with toe kick.
- Vanities do not come with handles (with the exception of Gabriola which is supplied with a plastic D-Pull).
- Cabinet depth does not include doors and drawers.