

THE PROJECT

STEP 1

Install our hanging rail secure to the inside closet wall studs using predetermined and marked measurements.



STEP 2

Easily lift and hang the components of each module by the notch precut for you.

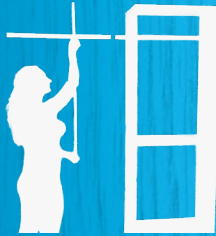

STEP 3

Connect the components with shelves, rods, and accessories. Lastly, put 'Everything in its place!'



www.eurorite.com

EURO-RITE
CABINETS
European Styling - Built Right!

We Also Offer:



Kitchens



Bathrooms



Custom Closets



EURO-RITE
CLOSETS

Everything In Its Place



ADVANTAGEONE

Stylish Look

Simple to Install

Adaptable Design

Quality Components



www.eurorite.com

Standard Modules

Hanging Tower 24"W x 72"H

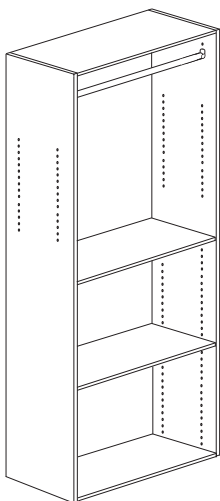

The starter tower is the most adaptable component in the advantage system. There are over 15 configuration options available with this unit.

Includes:

- 72" h vertical sides (2)
- 24" w fixed shelves (3)
- 24" w adjustable shelf (1)
- Closet rod (1)
- Rod bracket (2)
- Cleat (1) *not shown
- 32" hanging rail *not shown

C1 Chocolate

W1 White

Single Hang 36"W x 48"H

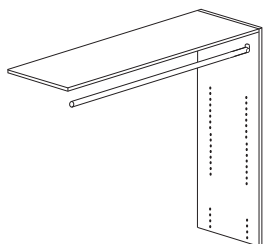

You can choose this component for your long hanging items like dresses, jackets and long pants or turn it into a shoe shelf. It can be cut for a custom fit.

Includes:

- 48" h vertical sides (1)
- 36" w fixed shelf (1)
- Closet rod (1)
- Rod bracket (2)
- Cleat (1) *not shown
- 32" hanging rail *not shown

C2 Chocolate

W2 White

Double Hang 36"W x 48"H

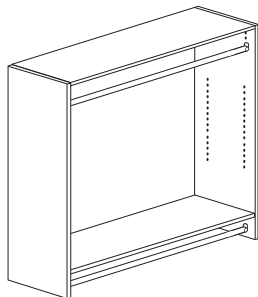

Instantly double your closet space with our double hang component. It can be cut for a custom fit.

Includes:

- 48" h vertical sides (2)
- 36" w fixed shelf (2)
- Closet rod (2)
- Rod bracket (4)
- Cleat (1) *not shown
- 32" hanging rail *not shown

C3 Chocolate

W3 White

Add-ons

Corner Shelves

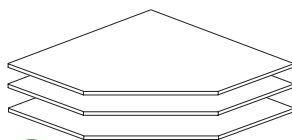

Optimize all the space in your closet with shelves. They extend 30" on both walls when placed between two sides and offer an adjustable shelf.

Includes:

- 30" W (along wall) Shelf (3)
- Wall Mount Rail (1)

C4 Chocolate

W4 White

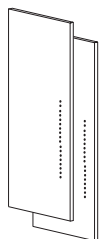

Closet Sides 48"H

The 48" closet panels come finished and pre-drilled for simple installation. Perfect to add to your Advantage closet system for additional storage space.

Includes:

- 14" D Vertical Side (2)

C5 Chocolate

W5 White

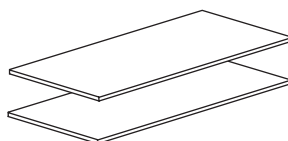

Shelf Pack 24"W

A shelf pack for our standard 24" tower. The shelves are adjustable and finished on the front edge.

Includes:

- 14" D Horizontal Shelf (2)
- Shelf Clips

C6 Chocolate

W6 White



Shelf Pack 36"W

A shelf pack for our standard 36" w modules. The shelves are adjustable and finished on the front edge.

Includes:

- 14" D Horizontal Shelf (2)
- Shelf Clips

C7 Chocolate

W7 White

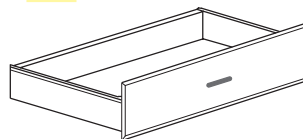

Drawer 24"W

Add space and function to your new closet, by adding drawers to the tower component.

Includes:

- Drawer sides, back & bottom
- Drawer Face
- Slides
- Assembly & Install Hardware

C8 Chocolate

W8 White

Accessories

A1 Chrome Basket

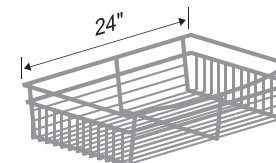

Add chrome baskets to the Hanging Tower for a unique and stylish type of closet storage. Unlike other baskets on the market, ours rest on top of the sides, eliminating the torque twist that is inherent in other types of pull out baskets.

A2 Tie/Belt Rack



Keep your belts and ties together in one place with this accessory, allowing you to locate easily the item you are looking for.

A3 Hanging Rail

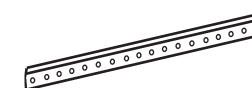

Simply mount this rail on the wall and then hang the vertical closet parts. It's simple and strong. You will have your closet installed in no time.

Online Planner

It is exciting and easy to create your very own dream closet using our "Online Planner" design tool. Simply enter your wall dimensions and a design is created just for you. From there you can make changes, try different configurations and instantly personalize the layout and design of your closet. Take all the time you like until you have created the perfect closet for your space & budget.

It's simple and fun...

www.eurorite.com/closet-planner

Define the Space

Reach-in (by-pass)



By-pass closets are in every home, in many rooms. They are easy to design and organize. Keep in mind that with by-pass doors the centre of the closet is covered by doors so the tower should be placed to one side or the other.

Reach-in (by-fold)

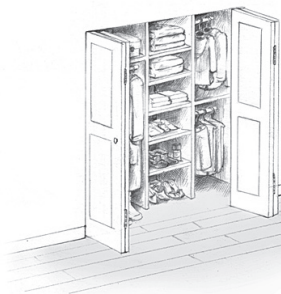

As opposed to the by-pass style, when you have bi-fold doors, it is best to place the modules closer to the middle of your by-fold doors. Frequent use items can be stored in the middle unit.

Walk-in

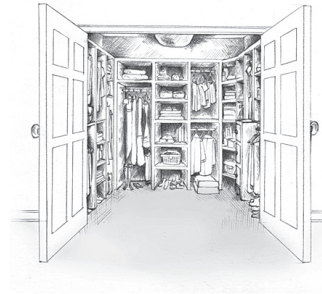

Walk in closets are very flexible when it comes to where you need storage and how you want to install the shelving and components. Have fun with your design thinking about all you want to store and have a place for.

Measure the Space

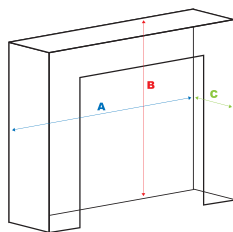

Inside Closet Dimensions

Measure the inside dimensions of your reach in closet. Most reach in closets have doors, either by-pass or by-fold. Fill out the dimensions according to the doors you have.

TIP: It is best to measure an empty closet. Walls are rarely square, flat or level. Measure width in different places (top, middle, bottom)

Width (A)

Height (B)

Depth (C)

Reach-in (by-pass)

To measure by-pass door openings, move the doors to the right and take measurement E1. Then to the left and take E2. D1 & D2 will be from the inside of the left and right wall to the edge of the door opening.

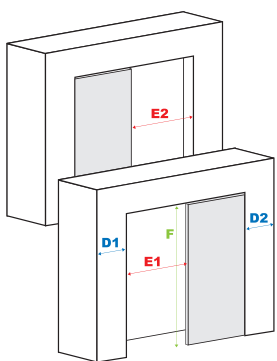

Return (D1)

Return (D2)

Width (E1)

Width (E2)

Height (F)

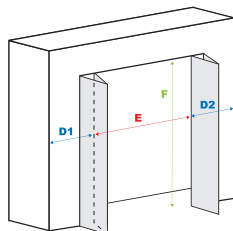

Reach-in (by-fold)

When measuring a by-fold door opening, ensure the doors are resting open. Measurements D1 and D2 will be from the inside of the left and right wall to the edge of the doors at the opening.

Return (D1)

Return (D2)

Width (E)

Height (F)

Walk-in

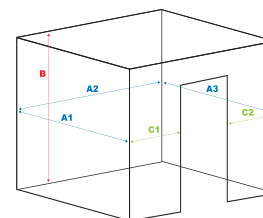

Walk-in style closets are simple to measure since the door opening does not usually affect the design. Take note of windows, vents or access panels.

Width (A1)

Width (A2)

Width (A3)

Return (C1)

Height (B)

Width (C2)

SAMPLE LAYOUTS Our Advantage closet series offers storage and organized space for any closet size and shape. Choose drawers, baskets, hanging rods or shelves. Choose one or two...or all! There is 'A Place for Everything' with our closet program. We've shown a few sample layouts on this page using the **CHOCOLATE** codes, however everything is also available in **WHITE**. The combinations are endless. *For MORE sample layouts, visit our website at www.eurorite.com/closets*

2' LAYOUTS

Have a narrow space like a linen or ensuite closet? Start with our tower and add from our accessories and components to best utilize this small space.

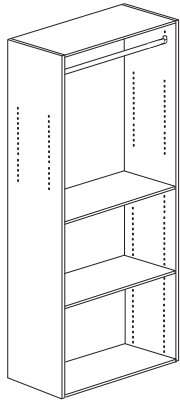

ITEM C1
Closet Tower 24" w
24" w x 72" h x 14" d

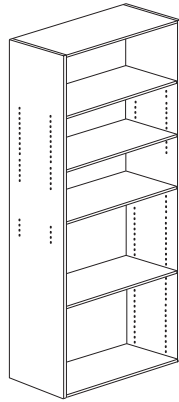

ITEM C1 + C6
Closet Tower 24" w
24" w x 72" h x 14" d
+
2 Shelf Pack 24"

Perfect for sweaters and more bulky items.

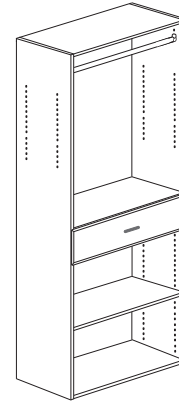

ITEM C1 + C8
Closet Tower 24" w
24" w x 72" h x 14" d
+
Drawer 24"

Can have multiple drawers to create a dresser-like space.



ITEM C1 + A1 x2
Closet Tower 24" w
24" w x 72" h x 14" d
+
2 Chrome Basket 24"

Perfect for sweaters and more bulky items.

3' - 5' LAYOUTS

Start with a combination of our standard modules, add components and accessories. You'll be amazed with what you can come up with. Our standard single and double hang modules can be cut to fit.

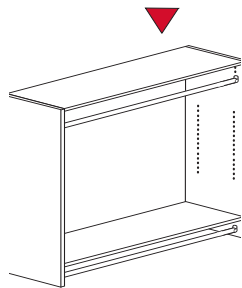

ITEM C3 + C5
Double Hang (Cut to size)
+
Closet sides
(1 extra needed)

width 3' (36")

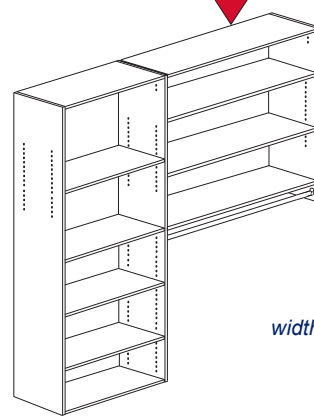

ITEM C1 + C3 + C6 + C7
Closet Tower 24" w
24" w x 72" h x 14" d
+
Single Hang (Cut to 24")
+
2 Shelf Pack 24"
+
2 Shelf Pack 36" (Cut to 24")

width 4' (48")

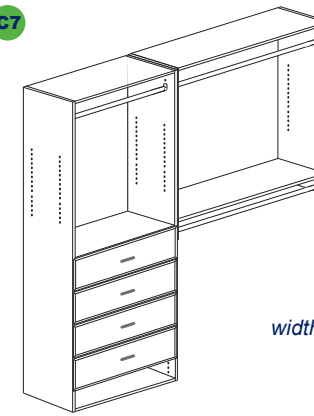

ITEM C1 + C3 + C8 x4
Closet Tower 24" w
24" w x 72" h x 14" d
+
Double Hang 36"
+
4 - Drawer 24"

width 5' (60")

6-8' LAYOUTS

Same idea as the 4'-5' but larger size closets can fit more component options

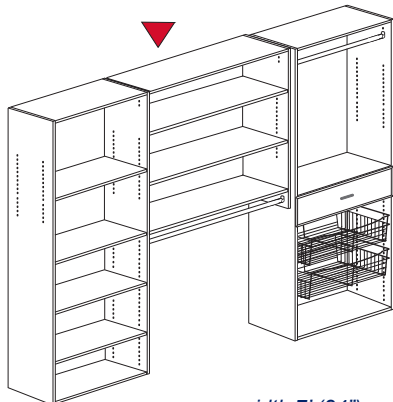

ITEM C1 x2 + C3 + C6 + C7 + C8 + A1 x2
Closet Tower 24" w
24" w x 72" h x 14" d
+
Double Hang (Cut to 36")
+
1 Shelf Pack 24"
+
1 Shelf Pack 36" (Cut to 36")
+
Drawer 24"
+
2 Chrome Baskets 24"

width 7' (84")

WALK IN LAYOUT

Start with a combination of our standard modules, add components and accessories. You'll be amazed with what you can come up with. Our standard single and double hang modules can be cut to fit. The layouts and configurations are endless!

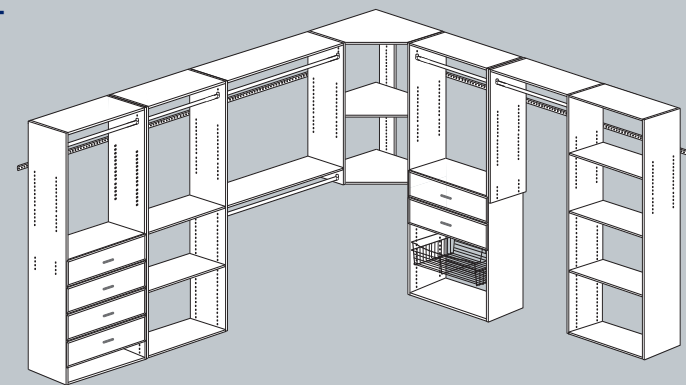

cut here ▼

cut here ▼

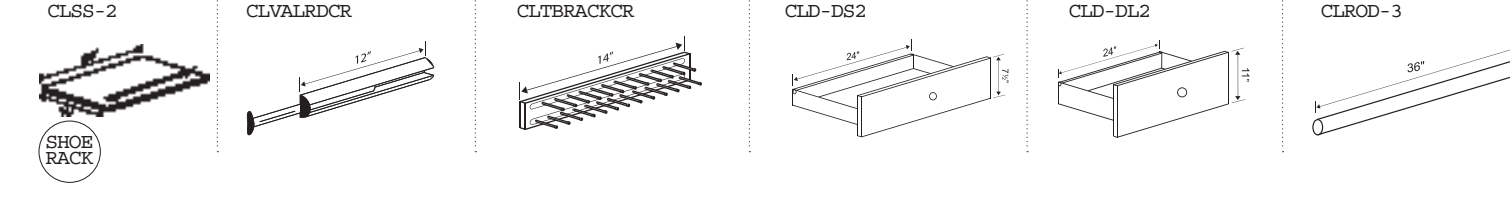
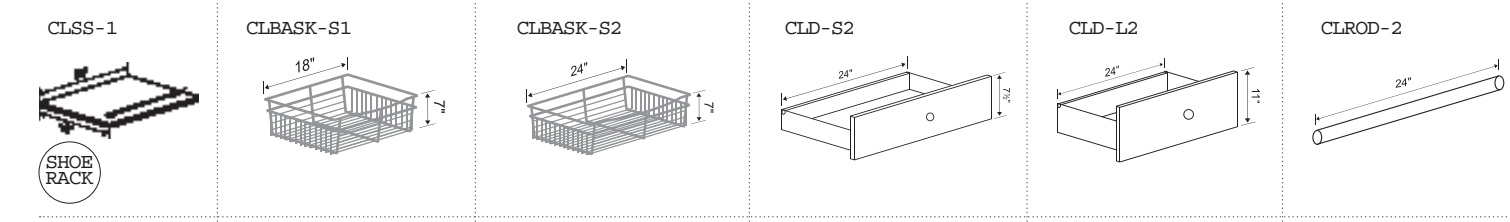
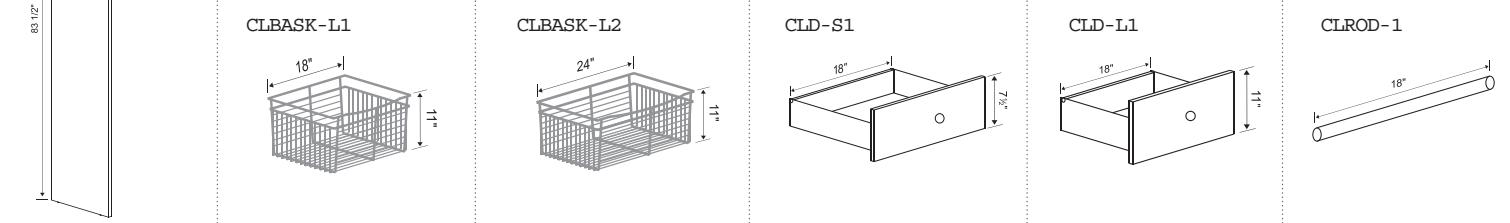
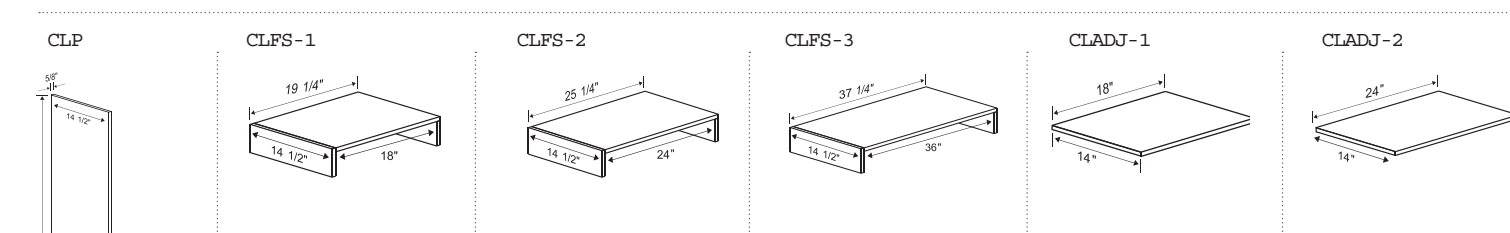
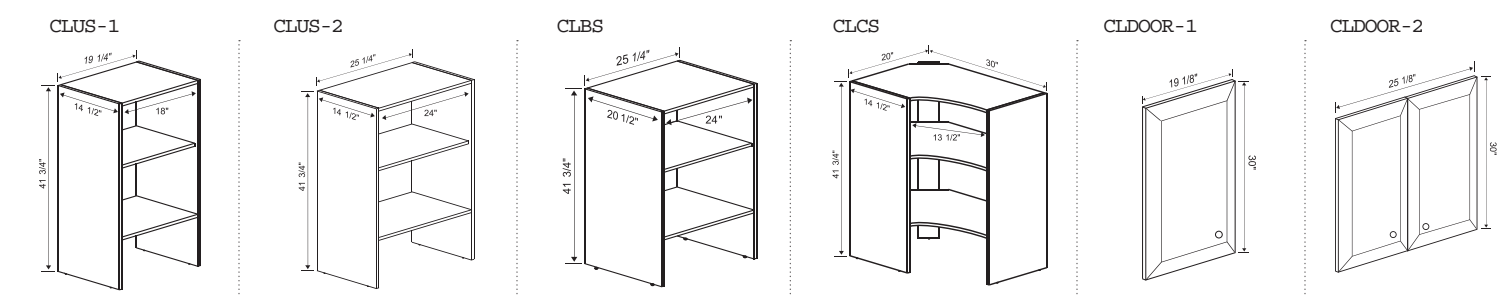

Standard Modules CLP's shown in white are not included in parts list.

Double Short Hanging
2 CLFS 2 CLROD

Probably the most common in closet organization. Two short hanging rods maximizes hanging space for shirts, blouses, pants and sport coats.

Long Hanging
2 CLFS 1 CLROD

This module is intended for housecoats, long dresses and gowns.

Semi-Short Hanging
1 CLUS 1 CLROD

The hanging length here is ideal for short dresses, pants hung by the cuff and coats. There is still space for folded clothes in the shelving above.

Short Hanging with Shelves Above
1 CLUS 1 CLROD 1 CLFS

A good combination of shelving and short hanging. Folded clothes are easily accessible while still providing space for hanging items.

Short Hanging with Shelves Below
1 CLUS 1 CLROD 1 CLFS

A good combination of shelving and short hanging. The shelving provides space for shoes and accessories (like drawers and baskets for clothing items).

Shelf Tower
2 CLUS

Maximum shelf space for folded clothes. Extra shelves, drawers and baskets can be added. Can also be duplicated with corner and 20" deep units.

Design Grid Use the grids below to plan and draw your closet layout.

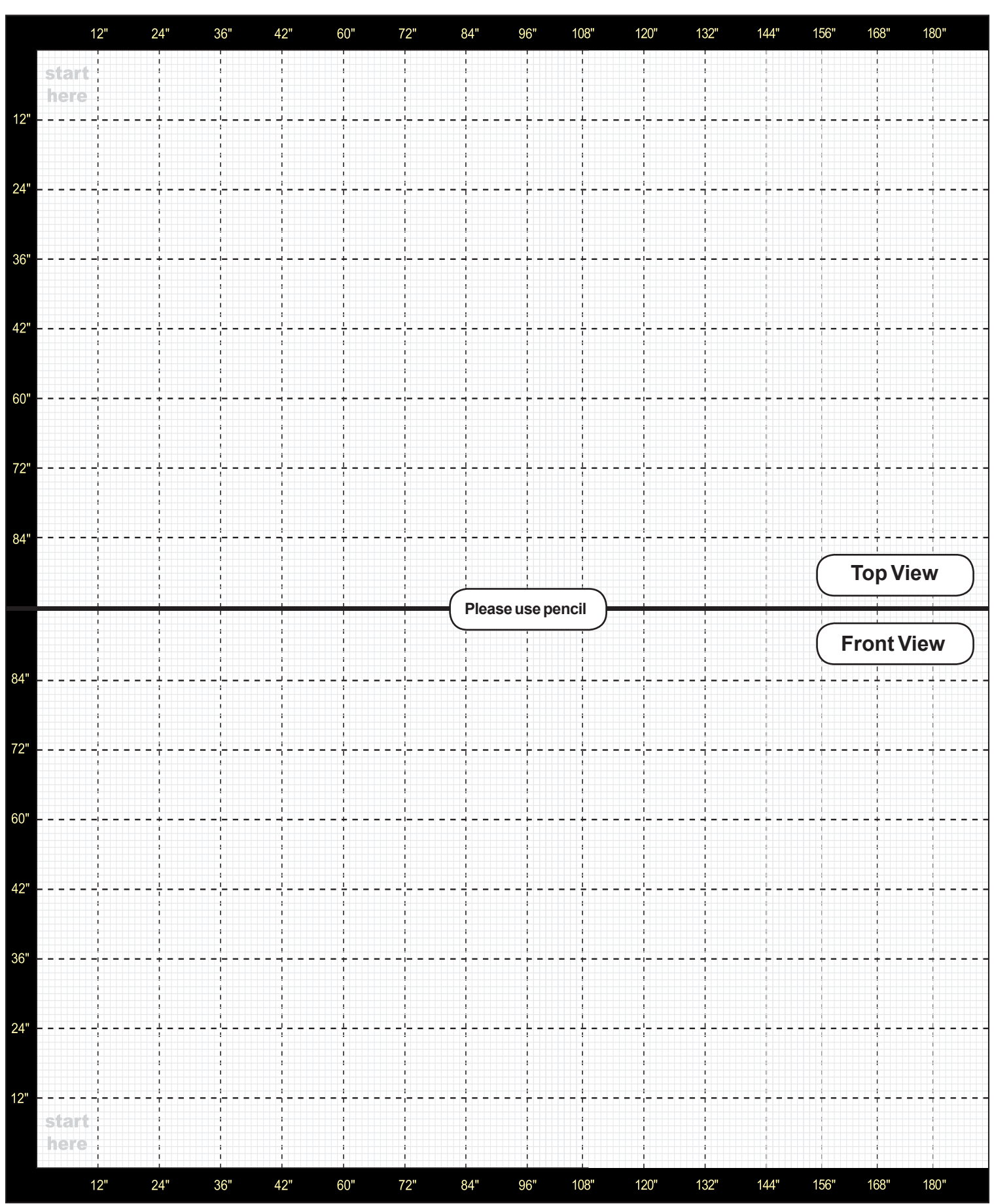

Measuring Reach-in and Walk-in Closets

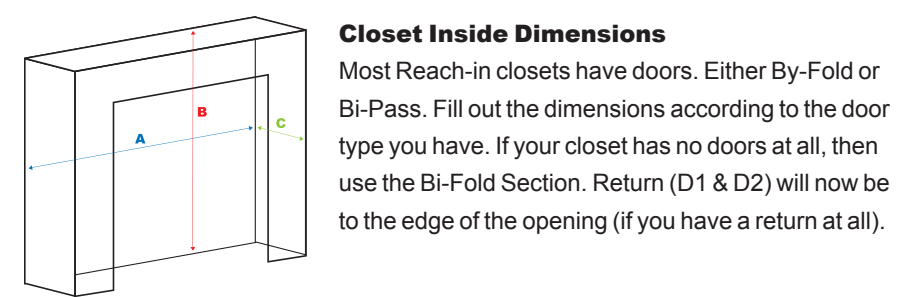

Closet Inside Dimensions
Most Reach-in closets have doors. Either By-Fold or Bi-Pass. Fill out the dimensions according to the door type you have. If your closet has no doors at all, then use the Bi-Fold Section. Return (D1 & D2) will now be to the edge of the opening (if you have a return at all).

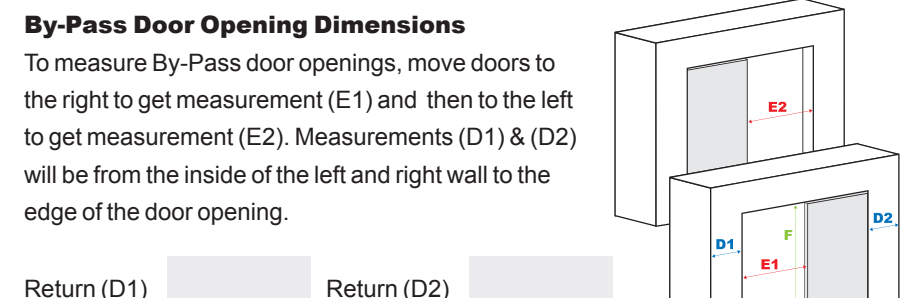

By-Pass Door Opening Dimensions
To measure By-Pass door openings, move doors to the right to get measurement (E1) and then to the left to get measurement (E2). Measurements (D1) & (D2) will be from the inside of the left and right wall to the edge of the door opening.

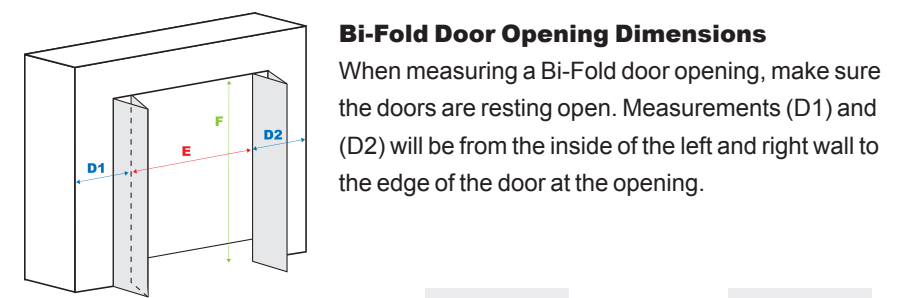

Bi-Fold Door Opening Dimensions
When measuring a Bi-Fold door opening, make sure the doors are resting open. Measurements (D1) and (D2) will be from the inside of the left and right wall to the edge of the door at the opening.

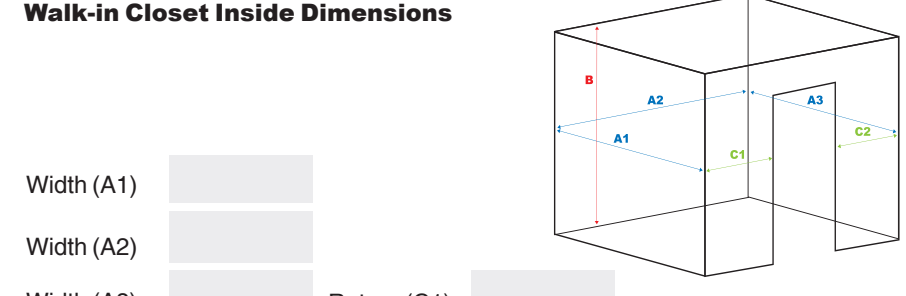

Walk-in Closet Inside Dimensions

Tip: It is best to have the closet empty of clothes when measuring. Walls are rarely square, flat or level. When measuring Width (A), it is always best to measure in various places (top,middle,bottom). Take the smallest measurement and subtract 1/2" if it's under 6 feet, 3/4" if it's 6 to 10 feet and 1" if it's over ten feet. This will ensure a problem free fit.

Order Form

COMPONENT	QTY	PRICE	EX. PRICE
CLUS-1			
CLUS-2			
CLBS			
CLCS			
CLFS-1			
CLFS-2			
CLFS-3			
CLP			
CLROD-1			
CLROD-2			
CLROD-3			
Components Subtotal (A)			

ACCESSORIES	QTY	PRICE	EX. PRICE
CLADJ-1			
CLADJ-2			
CLTRACKCR			
CLD-S1			
CLD-S2			
CLD-L1			
CLD-L2			
CLD-DS2			
CLD-DL2			
CLDOOR-1			
CLDOOR-2			
CLBASK-S1			
CLBASK-S2			
CLBASK-L1			
CLBASK-L2			
CLVALRDCR			
Accessories Subtotal (B)			
Grand Total (A+B)			

DESIGN YOUR OWN CLOSET!

Know the Difference There are 3 different styles of closets: the by-pass door style, bi-fold style, and the walk-in closet. Your closet design will depend entirely on the style of closet you own. Learn the difference and start building your dream closet! Here are a few sample layouts recommended for the different closet styles.

Available in: Grey | White | Chocolate Pear | Antique White

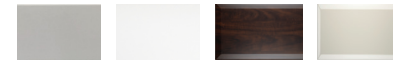

By-Pass Door
Sample Layout

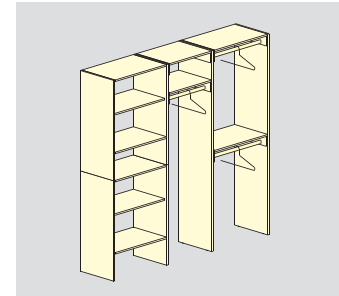

UP TO 6 FEET

2 CLUS-2 2 CLP
4 CLFS-2 3 CLROD-2

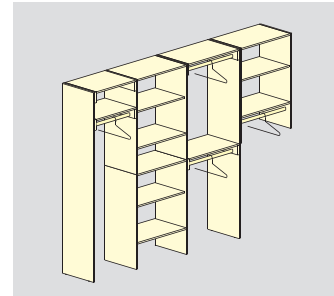

UP TO 8 FEET

3 CLUS-2 2 CLP
2 CLFS-1 1 CLROD-1
2 CLFS-2 3 CLROD-2

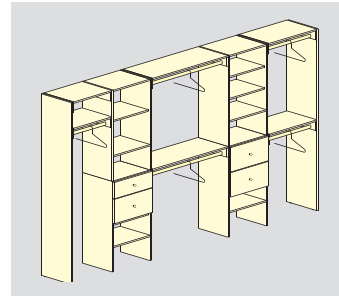

UP TO 10 FEET

4 CLUS-1
2 CLFS-1 2 CLFS-2 2 CLFS-3
2 CLP 1 CLROD-1 2 CLROD-2
2 CLROD-3 3 CLD-11 1 CLD-SL

With the by-pass door style, a shelf tower is most advantageous when placed closer to an end of the closet. This allows easy access to your shelf items when sliding open your closet door. Keep that in mind when designing for by-pass door closets of any size!

Bi-Fold Door
Sample Layout

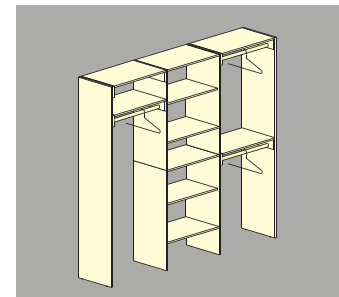
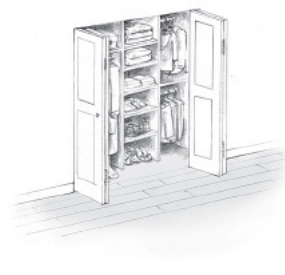

UP TO 6 FEET

2 CLUS-2 4 CLFS-2
2 CLP 3 CLROD-2

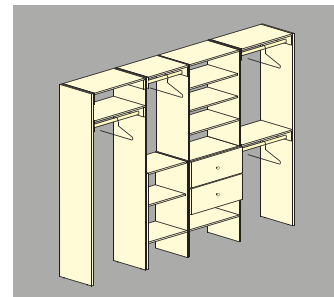

UP TO 8 FEET

1 CLUS-1
2 CLUS-2 1 CLFS-1 3 CLP
4 CLFS-2 1 CLROD-1
3 CLROD-2 2 CLD-L2

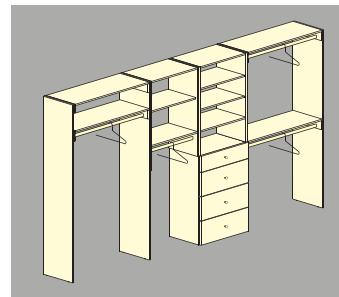

UP TO 10 FEET

3 CLUS-2 4 CLFS-3 3 CLP
1 CLROD-2 1 CLROD-3
3 CLD-L2 1 CLD-S2

Opposite to the by-pass door style, it is best to place shelving closer to the middle of your bi-fold door closet. Heavier items can be tucked away at the two ends of your bi-fold closet while lighter, more frequently used items can be stored in the middle shelving.

Walk-In Closet
Sample Layout

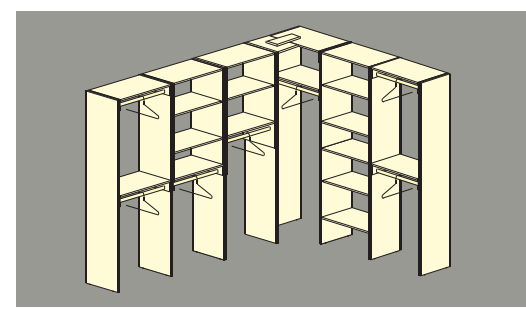

4 CLUS 7 CLROD
8 CLFS 6 CLP

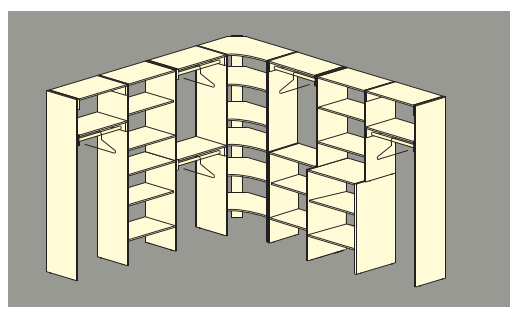

4 CLUS 2 CLP 2 CLCS
7 CLFS 5 CLROD 1 CLBS

Walk-in closets are extremely flexible as to where you prefer to have shelving, so have fun designing your walk-in closet the way you like it! Euro-Rite offers a corner shelving unit for maximum shelf storage space!

Get acquainted with our Closet Program Euro-Rite offers a closet program that is suitable for both contractors and Do-it-Yourself enthusiasts. Our stackable Ready-To-Assemble (RTA) units can be used in a multitude of combinations to increase any closet space. To help get you organized, we offer a variety of accessories, and drawer options.



Kitchens

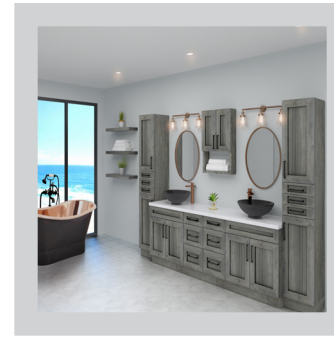

Bathroom



Closets

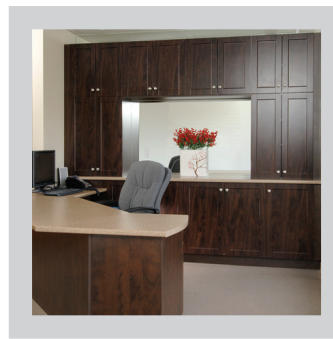

Office



Laundry



Entertainment



www.eurorite.com | 1-888-464-5063

ADVANTAGE PLUS

